

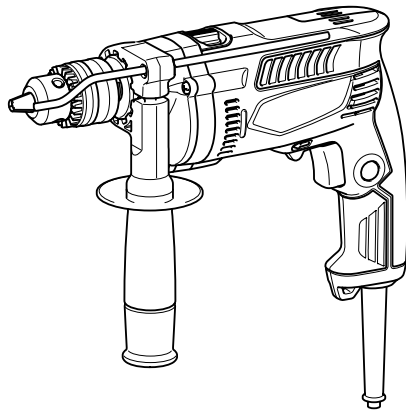

INSTRUCTION MANUAL

# Hammer Drill

M8100  
M8101



011088

 DOUBLE INSULATION

**IMPORTANT:** Read Before Using.

## ENGLISH (Original instructions)

# SPECIFICATIONS

Model	M8100	M8101
Capacities	Concrete	16 mm
	Wood	30 mm
	Steel	13 mm
No load speed (min <sup>-1</sup> )	0 - 3,200	
Blows per minute	0 - 48,000	
Overall length	296 mm	295 mm
Net weight	2.1 kg	2.0 kg
Safety class	II/III	

- Due to our continuing program of research and development, the specifications herein are subject to change without notice.
- Specifications may differ from country to country.
- Weight according to EPTA-Procedure 01/2003

END201-7

## Symbols

The following show the symbols used for the equipment. Be sure that you understand their meaning before use.



- Read instruction manual.



- DOUBLE INSULATION



- Only for EU countries  
Do not dispose of electric equipment together with household waste material! In observance of the European Directive, on Waste Electric and Electronic Equipment and its implementation in accordance with national law, electric equipment that have reached the end of their life must be collected separately and returned to an environmentally compatible recycling facility.

ENE039-1

## Intended use

The tool is intended for impact drilling in brick, concrete and stone as well as for drilling without impact in wood, metal, ceramic and plastic.

ENF002-2

## Power supply

The tool should be connected only to a power supply of the same voltage as indicated on the nameplate, and can only be operated on single-phase AC supply. They are double-insulated and can, therefore, also be used from sockets without earth wire.

ENG905-1

## Noise

The typical A-weighted noise level determined according to EN60745:

Sound pressure level ( $L_{pA}$ ) : 98 dB (A)  
Sound power level ( $L_{WA}$ ) : 109 dB (A)  
Uncertainty (K) : 3 dB (A)

## Wear ear protection

ENG900-1

## Vibration

The vibration total value (tri-axial vector sum) determined according to EN60745:

Work mode: impact drilling into concrete

Vibration emission ( $a_{h,D}$ ) : 16.5 m/s<sup>2</sup>

Uncertainty (K) : 2.0 m/s<sup>2</sup>

Work mode: drilling into metal

Vibration emission ( $a_{h,D}$ ) : 3.0 m/s<sup>2</sup>

Uncertainty (K) : 1.5 m/s<sup>2</sup>

ENG901-1

- The declared vibration emission value has been measured in accordance with the standard test method and may be used for comparing one tool with another.
- The declared vibration emission value may also be used in a preliminary assessment of exposure.

## WARNING:

- The vibration emission during actual use of the power tool can differ from the declared emission value depending on the ways in which the tool is used.
- Be sure to identify safety measures to protect the operator that are based on an estimation of exposure in the actual conditions of use (taking account of all parts of the operating cycle such as the times when the tool is switched off and when it is running idle in addition to the trigger time).

**For European countries only****EC Declaration of Conformity****Makita declares that the following Machine(s):**

Designation of Machine:

Hammer Drill

Model No./ Type: M8100, M8101

**Conforms to the following European Directives:**

2006/42/EC

They are manufactured in accordance with the following standard or standardized documents:

EN60745

The technical file in accordance with 2006/42/EC is available from:

Makita, Jan-Baptist Vinkstraat 2, 3070, Belgium

1.12.2014



000331

Yasushi Fukaya

Director

Makita, Jan-Baptist Vinkstraat 2, 3070, Belgium

GEA005-3

**General Power Tool Safety****Warnings**

**⚠ WARNING** Read all safety warnings and all instructions. Failure to follow the warnings and instructions may result in electric shock, fire and/or serious injury.

**Save all warnings and instructions for future reference.**

The term "power tool" in the warnings refers to your mains-operated (corded) power tool or battery-operated (cordless) power tool.

**Work area safety**

1. **Keep work area clean and well lit.** Cluttered or dark areas invite accidents.
2. **Do not operate power tools in explosive atmospheres, such as in the presence of flammable liquids, gases or dust.** Power tools create sparks which may ignite the dust or fumes.
3. **Keep children and bystanders away while operating a power tool.** Distractions can cause you to lose control.

**Electrical safety**

4. **Power tool plugs must match the outlet. Never modify the plug in any way. Do not use any adapter plugs with earthed (grounded) power tools.** Unmodified plugs and matching outlets will reduce risk of electric shock.

5. **Avoid body contact with earthed or grounded surfaces such as pipes, radiators, ranges and refrigerators.** There is an increased risk of electric shock if your body is earthed or grounded.
6. **Do not expose power tools to rain or wet conditions.** Water entering a power tool will increase the risk of electric shock.
7. **Do not abuse the cord. Never use the cord for carrying, pulling or unplugging the power tool. Keep cord away from heat, oil, sharp edges or moving parts.** Damaged or entangled cords increase the risk of electric shock.
8. **When operating a power tool outdoors, use an extension cord suitable for outdoor use.** Use of a cord suitable for outdoor use reduces the risk of electric shock.
9. **If operating a power tool in a damp location is unavoidable, use a residual current device (RCD) protected supply.** Use of an RCD reduces the risk of electric shock.
10. **Use of power supply via a RCD with a rated residual current of 30 mA or less is always recommended.**

**Personal safety**

11. **Stay alert, watch what you are doing and use common sense when operating a power tool. Do not use a power tool while you are tired or under the influence of drugs, alcohol or medication.** A moment of inattention while operating power tools may result in serious personal injury.
12. **Use personal protective equipment. Always wear eye protection.** Protective equipment such as dust mask, non-skid safety shoes, hard hat, or hearing protection used for appropriate conditions will reduce personal injuries.
13. **Prevent unintentional starting. Ensure the switch is in the off-position before connecting to power source and/or battery pack, picking up or carrying the tool.** Carrying power tools with your finger on the switch or energising power tools that have the switch on invites accidents.
14. **Remove any adjusting key or wrench before turning the power tool on.** A wrench or a key left attached to a rotating part of the power tool may result in personal injury.
15. **Do not overreach. Keep proper footing and balance at all times.** This enables better control of the power tool in unexpected situations.
16. **Dress properly. Do not wear loose clothing or jewellery. Keep your hair, clothing, and gloves away from moving parts.** Loose clothes, jewellery or long hair can be caught in moving parts.

17. **If devices are provided for the connection of dust extraction and collection facilities, ensure these are connected and properly used.** Use of dust collection can reduce dust-related hazards.

#### **Power tool use and care**

18. **Do not force the power tool. Use the correct power tool for your application.** The correct power tool will do the job better and safer at the rate for which it was designed.
19. **Do not use the power tool if the switch does not turn it on and off.** Any power tool that cannot be controlled with the switch is dangerous and must be repaired.
20. **Disconnect the plug from the power source and/or the battery pack from the power tool before making any adjustments, changing accessories, or storing power tools.** Such preventive safety measures reduce the risk of starting the power tool accidentally.
21. **Store idle power tools out of the reach of children and do not allow persons unfamiliar with the power tool or these instructions to operate the power tool.** Power tools are dangerous in the hands of untrained users.
22. **Maintain power tools. Check for misalignment or binding of moving parts, breakage of parts and any other condition that may affect the power tool's operation. If damaged, have the power tool repaired before use.** Many accidents are caused by poorly maintained power tools.
23. **Keep cutting tools sharp and clean.** Properly maintained cutting tools with sharp cutting edges are less likely to bind and are easier to control.
24. **Use the power tool, accessories and tool bits etc. in accordance with these instructions, taking into account the working conditions and the work to be performed.** Use of the power tool for operations different from those intended could result in a hazardous situation.

#### **Service**

25. **Have your power tool serviced by a qualified repair person using only identical replacement parts.** This will ensure that the safety of the power tool is maintained.
26. **Follow instruction for lubricating and changing accessories.**
27. **Keep handles dry, clean and free from oil and grease.**

## **HAMMER DRILL SAFETY WARNINGS**

1. **Wear ear protectors when impact drilling.** Exposure to noise can cause hearing loss.
2. **Use auxiliary handle(s), if supplied with the tool.** Loss of control can cause personal injury.
3. **Hold power tool by insulated gripping surfaces, when performing an operation where the cutting accessory may contact hidden wiring or its own cord.** Cutting accessory contacting a "live" wire may make exposed metal parts of the power tool "live" and could give the operator an electric shock.
4. **Always be sure you have a firm footing.** Be sure no one is below when using the tool in high locations.
5. **Hold the tool firmly with both hands.**
6. **Keep hands away from rotating parts.**
7. **Do not leave the tool running. Operate the tool only when hand-held.**
8. **Do not touch the bit or the workpiece immediately after operation; they may be extremely hot and could burn your skin.**
9. **Some material contains chemicals which may be toxic. Take caution to prevent dust inhalation and skin contact. Follow material supplier safety data.**

## **SAVE THESE INSTRUCTIONS.**

### **⚠WARNING:**

**DO NOT** let comfort or familiarity with product (gained from repeated use) replace strict adherence to safety rules for the subject product. **MISUSE** or failure to follow the safety rules stated in this instruction manual may cause serious personal injury.

## ASSEMBLY

### Installing side grip (auxiliary handle)

#### ⚠ CAUTION:

- Always be sure that the tool is switched off and unplugged before installing or removing the side grip.

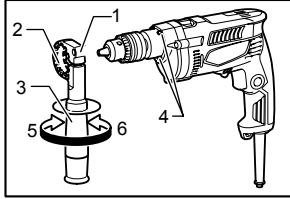

011089

Always use the side grip to ensure operating safety. Install the side grip so that the teeth fit in between the protrusions on the tool barrel. Then tighten the grip by turning clockwise at the desired position. It may be swung 360° so as to be secured at any position.

### Installing or removing drill bit

#### ⚠ CAUTION:

- Always be sure that the tool is switched off and unplugged before installing or removing the bit.

### For Model M8100

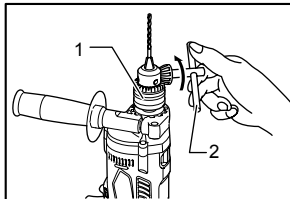

011090

To install the bit, place it in the chuck as far as it will go. Tighten the chuck by hand. Place the chuck key in each of the three holes and tighten clockwise. Be sure to tighten all three chuck holes evenly. To remove the bit, turn the chuck key counterclockwise in just one hole, then loosen the chuck by hand. After using the chuck key, be sure to return it to the original position.

### For Model M8101

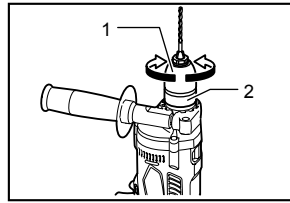

- Sleeve
- Ring

011095

Hold the ring and turn the sleeve counterclockwise to open the chuck jaws. Place the bit in the chuck as far as it will go. Hold the ring firmly and turn the sleeve clockwise to tighten the chuck.

To remove the bit, hold the ring and turn the sleeve counterclockwise.

### Depth gauge

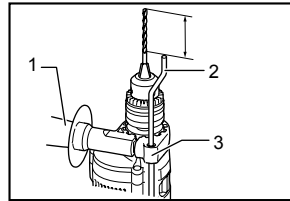

- Side grip
- Depth gauge
- Grip base

011091

The depth gauge is convenient for drilling holes of uniform depth. Loosen the side grip and insert the depth gauge into the hole in the grip base. Adjust the depth gauge to the desired depth and tighten the side grip.

#### NOTE:

The depth gauge cannot be used at the position where the depth gauge strikes against the gear housing.

## FUNCTIONAL DESCRIPTION

### Switch action

#### ⚠CAUTION:

- Before plugging in the tool, always check to see that the switch trigger actuates properly and returns to the "OFF" position when released.

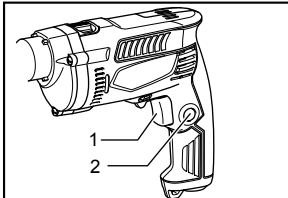

1. Switch trigger
2. Lock button

011092

To start the tool, simply pull the switch trigger. Tool speed is increased by increasing pressure on the switch trigger. Release the switch trigger to stop. For continuous operation, pull the switch trigger, push in the lock button and then release the switch trigger. To stop the tool from the locked position, pull the switch trigger fully, then release it.

### Reversing switch action

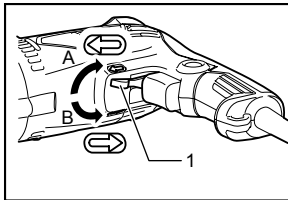

1. Reversing switch lever

011093

This tool has a reversing switch to change the direction of rotation. Move the reversing switch lever to the ⇐ position (A side) for clockwise rotation or to the ⇒ position (B side) for counterclockwise rotation.

#### ⚠CAUTION:

- Always check the direction of rotation before operation.
- Use the reversing switch only after the tool comes to a complete stop. Changing the direction of rotation before the tool stops may damage the tool.

### Selecting the action mode

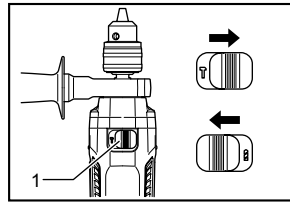

1. Action mode changing lever

011094

This tool has an action mode change lever. For rotation with hammering, slide the action mode change lever to the right ( ⇨ symbol). For rotation only, slide the action mode change lever to the left ( ⇦ symbol).

#### ⚠CAUTION:

- Always slide the action mode change lever all the way to your desired mode position. If you operate the tool with the lever positioned halfway between the mode symbols, the tool may be damaged.

## OPERATION

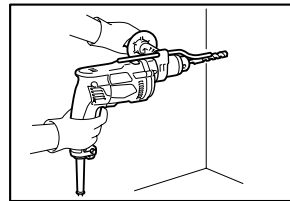

015487

Always hold the tool only by the handle when performing an operation. Do not touch the metal part.

### Hammer drilling operation

#### ⚠CAUTION:

- There is tremendous and sudden twisting force exerted on the tool/bit at the time of hole break-through, when the hole becomes clogged with chips and particles, or when striking reinforcing rods embedded in the concrete. Always use the side grip (auxiliary handle) and firmly hold the tool by both side grip and switch handle during operations. Failure to do so may result in the loss of control of the tool and potentially serve injury.

When drilling in concrete, granite, tile, etc., slide the action mode change lever to the position of ⇨ symbol to use "rotation with hammering" action. Be sure to use a tungsten-carbide tipped bit. Do not apply more pressure when the hole becomes clogged with chips or particles. Instead, run the tool at an idle, then remove the bit partially from the hole. By repeating this several times, the hole will be cleaned out.

---

After drilling the hole, use the blow-out bulb to clean the dust out of the hole.

### **Drilling operation**

When drilling in wood, metal or plastic materials, slide the action mode change lever to the position of  symbol to use "rotation only" action.

#### **Drilling in wood**

When drilling in wood, the best results are obtained with wood drills equipped with a guide screw. The guide screw makes drilling easier by pulling the bit into the workpiece.

#### **Drilling in metal**

To prevent the bit from slipping when starting a hole, make an indentation with a center-punch and hammer at the point to be drilled. Place the point of the bit in the indentation and start drilling. Use a cutting lubricant when drilling metals. The exceptions are iron and brass which should be drilled dry.

#### **CAUTION:**

- Pressing excessively on the tool will not speed up the drilling. In fact, this excessive pressure will only serve to damage the tip of your bit, decrease the tool performance and shorten the service life of the tool.
- There is a tremendous force exerted on the tool/bit at the time of hole break through. Hold the tool firmly and exert care when the bit begins to break through the workpiece.
- A stuck bit can be removed simply by setting the reversing switch to reverse rotation in order to back out. However, the tool may back out abruptly if you do not hold it firmly.
- Always secure small workpieces in a vise or similar hold-down device.

## **MAINTENANCE**

#### **CAUTION:**

- Always be sure that the tool is switched off and unplugged before carrying out any work on the tool.
- Never use gasoline, benzine, thinner, alcohol or the like. Discoloration, deformation or cracks may result.

To maintain product safety and reliability, repairs, maintenance or adjustment should be carried out by a Makita Authorized Service Center.

**Makita** Jan-Baptist Vinkstraat 2, 3070, Belgium  
**Makita Corporation** Anjo, Aichi, Japan