

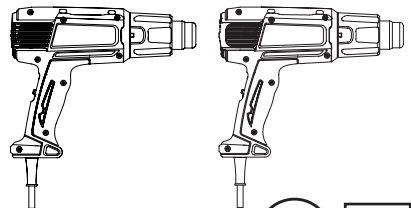

EN	Heat Gun	INSTRUCTION MANUAL	3
ZHCN	热风枪	使用说明书	10
ZHTW	熱風槍	使用說明書	17
KO	열풍기	원본 취급 설명서	23
ID	Heat Gun	PETUNJUK PENGGUNAAN	29
VN	Máy Thổi Hơi Nóng Cầm Tay Hoạt Động Bằng Động Cơ Điện	TÀI LIỆU HƯỚNG DẪN	36
TH	ปืนเป่าลมร้อน	คู่มือการใช้งาน	43

HG6530V
HG6531C



HG6530V

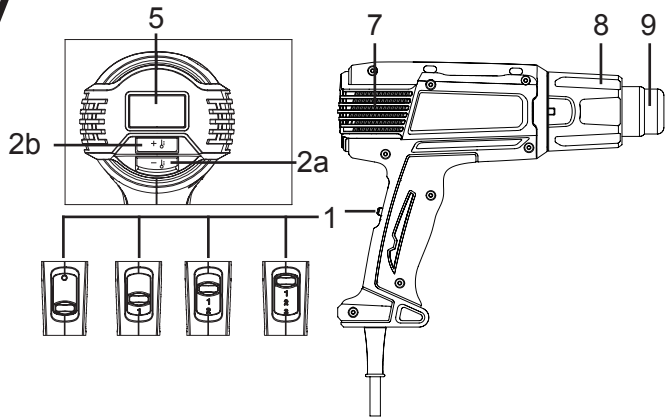

HG6531C

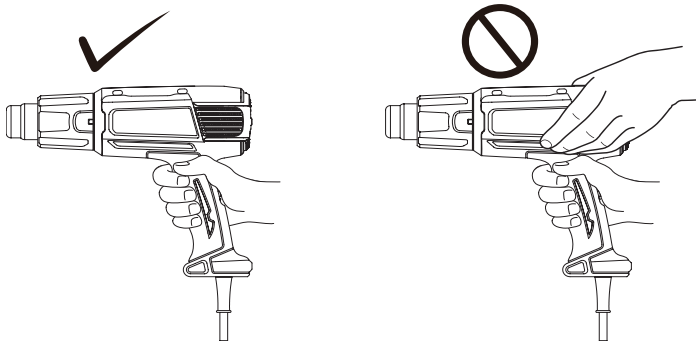
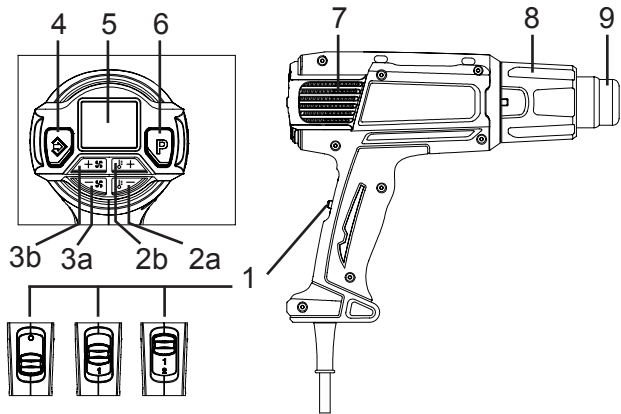

Fig.1

WARNING

This appliance cannot be used by children or persons with reduced physical, sensory or mental capabilities or lack of experience and knowledge. Children shall not play with the appliance. Cleaning and user maintenance shall not be made by children.

If the supply cord is damaged, it must be replaced by the manufacturer, its service agent or similarly qualified persons in order to avoid a hazard.

A fire may result if the appliance is not used with care, therefore:

- be careful when using the appliance in places where there are combustible materials;
- do not apply to the same place for a long time;
- do not use in presence of an explosive atmosphere;
- be aware that heat may be conducted to combustible materials that are out of sight;
- place the appliance on its stand after use and allow it to cool down before storage;
- do not leave the appliance unattended when it is switched on.

INTENDED USE

Your heat gun has been designed for stripping paint, soldering pipes, shrinking PVC, welding and bending plastic as well as general drying and thawing purposes.



WARNING: Read this manual and general safety Instructions carefully before using the appliance, for your own safety. Your power tool should only be passed on together with these instructions.



The tool should be connected only to a power supply of the same voltage as indicated on the nameplate, and can only be operated on single-phase AC supply. They are double-insulated and can, therefore, also be used from sockets without earth wire.



Hot surfaces - Burns to fingers or hands.

DESCRIPTION

1. Slide switch
2. Temperature setting button (2a -, 2b+)
3. Air volume setting button (3a -, 3b +)
4. Confirmation button
5. LCD

6. Preset button
7. Air inlet
8. Front cover
9. Nozzle

PACKAGE CONTENT LIST

- Check the appliance, the power cord, the power plug and all accessories for transportation damages.



WARNING: Packing materials are not toys! Children must not play with plastic bags! Danger of suffocation!

- 1 Heat gun
- 1 Set of accessories (Accessories may not be necessarily be included)
- 1 Instruction manual



When parts are missing or damaged, please contact your dealer.

GENERAL POWER TOOL SAFETY WARNINGS

Read all safety warnings, instructions, illustrations and specifications provided with this power tool. Failure to follow all instructions listed below may result in electric shock, fire and/or serious injury.

Save all warnings and instructions for future reference.

The term "power tool" in the warnings refers to your mains-operated (corded) power tool or battery-operated (cordless) power tool.

Work area safety

1. **Keep work area clean and well lit.** Cluttered or dark areas invite accidents.
2. **Do not operate power tools in explosive atmospheres, such as in the presence of flammable liquids, gases or dust.** Power tools create sparks which may ignite the dust or fumes.
3. **Keep children and bystanders away while operating a power tool.** Distractions can cause you to lose control.

Electrical Safety

1. **Power tool plugs must match the outlet. Never modify the plug in any way. Do not use any adapter plugs with earthed (grounded) power tools.** Unmodified plugs and matching outlets will reduce risk of electric shock.
2. **Avoid body contact with earthed or grounded surfaces, such as pipes, radiators, ranges and refrigerators.** There is an increased risk of electric shock if your body is earthed or grounded.
3. **Do not expose power tools to rain or wet conditions.** Water entering a power tool will increase the risk of electric shock.
4. **Do not abuse the cord. Never use the cord for carrying, pulling or unplugging the power tool. Keep cord away from heat, oil, sharp edges or moving parts.** Damaged or entangled cords increase the risk of electric shock.
5. **When operating a power tool outdoors, use an extension cord suitable for outdoor use.** Use of a cord suitable for outdoor use reduces the risk of electric shock.
6. **If operating a power tool in a damp location is unavoidable, use a residual current device (RCD) protected supply.** Use of an RCD reduces the risk of electric shock.
7. **Use of power supply via an RCD with a rated residual current of 30 mA or less is always recommended.**
8. **Power tools can produce electromagnetic fields (EMF) that are not harmful to the user.** However, users of pacemakers and other similar medical devices should contact the maker of their device and/or doctor for advice before operating this power tool.
9. **Do not touch the power plug with wet hands.**
10. **If the cord is damaged, have it replaced by the manufacturer or his agent in order to avoid a safety hazard.**

Personal Safety

1. **Stay alert, watch what you are doing and use common sense when operating a power tool. Do not use a power tool while you are tired or under the influence of drugs, alcohol or medication.** A moment of inattention while operating power tools may result in serious personal injury.
2. **Use personal protective equipment. Always wear eye protection.** Protective equipment such

as a dust mask, non-skid safety shoes, hard hat or hearing protection used for appropriate conditions will reduce personal injuries.

3. **Prevent unintentional starting. Ensure the switch is in the off-position before connecting to power source and/or battery pack, picking up or carrying the tool.** Carrying power tools with your finger on the switch or energising power tools that have the switch on invites accidents.
4. **Remove any adjusting key or wrench before turning the power tool on.** A wrench or a key left attached to a rotating part of the power tool may result in personal injury.
5. **Do not overreach. Keep proper footing and balance at all times.** This enables better control of the power tool in unexpected situations.
6. **Dress properly. Do not wear loose clothing or jewellery. Keep your hair and clothing away from moving parts.** Loose clothes, jewellery or long hair can be caught in moving parts.
7. **If devices are provided for the connection of dust extraction and collection facilities, ensure these are connected and properly used.** Use of dust collection can reduce dust-related hazards.
8. **Do not let familiarity gained from frequent use of tools allow you to become complacent and ignore tool safety principles.** A careless action can cause severe injury within a fraction of a second.
9. **Always wear protective goggles to protect your eyes from injury when using power tools. The goggles must comply with ANSI Z87.1 in the USA, EN 166 in Europe, or AS/NZS 1336 in Australia/New Zealand. In Australia/New Zealand, it is legally required to wear a face shield to protect your face, too.**

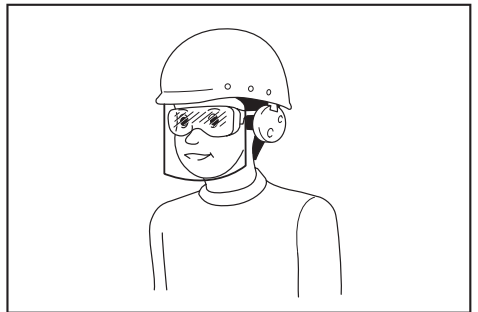

It is an employer's responsibility to enforce the use of appropriate safety protective equipments by the tool operators and by other persons in the immediate working area.

Power tool use and care

1. **Do not force the power tool. Use the correct power tool for your application.** The correct power tool will do the job better and safer at the rate for which it was designed.
2. **Do not use the power tool if the switch does not turn it on and off.** Any power tool that cannot be controlled with the switch is dangerous and must be repaired.
3. **Disconnect the plug from the power source**

and/or remove the battery pack, if detachable, from the power tool before making any adjustments, changing accessories, or storing power tools. Such preventive safety measures reduce the risk of starting the power tool accidentally.

4. **Store idle power tools out of the reach of children and do not allow persons unfamiliar with the power tool or these instructions to operate the power tool.** Power tools are dangerous in the hands of untrained users.
5. **Maintain power tools and accessories. Check for misalignment or binding of moving parts, breakage of parts and any other condition that may affect the power tool's operation. If damaged, have the power tool repaired before use.** Many accidents are caused by poorly maintained power tools.
6. **Keep cutting tools sharp and clean.** Properly maintained cutting tools with sharp cutting edges are less likely to bind and are easier to control.
7. **Use the power tool, accessories and tool bits etc. in accordance with these instructions, taking into account the working conditions and the work to be performed.** Use of the power tool for operations different from those intended could result in a hazardous situation.
8. **Keep handles and grasping surfaces dry, clean and free from oil and grease.** Slippery handles and grasping surfaces do not allow for safe handling and control of the tool in unexpected situations.
9. **When using the tool, do not wear cloth work gloves which may be entangled.** The entanglement of cloth work gloves in the moving parts may result in personal injury.

Service

1. **Have your power tool serviced by a qualified repair person using only identical replacement parts.** This will ensure that the safety of the power tool is maintained.
2. **Follow instruction for lubricating and changing accessories.**

ADDITIONAL SAFETY INSTRUCTIONS FOR HEAT GUN

- **Do not place your hand over the air vents or block the vents in any way.**
- **The nozzle and accessories of this tool become extremely hot during use. Let these parts cool down before touching.**
- **Always switch the tool off before putting it down.**







- **Do not leave the tool unattended while it is switched on.**
- **A fire may arise if the appliance is not used with care.**
- **Heat may be conducted to combustible materials that are out of sight. Do not use in a damp atmosphere, where flammable gases may be present or near combustible materials.**
- **Allow the tool to cool fully before storing.**
- **Ensure adequate ventilation as toxic fumes may be produced.**
- **Do not use as a hairdryer.**
- **Do not obstruct either the air intake or nozzle outlet, as this may cause excessive heat build-up resulting in damage to the tool.**
- **Do not direct the hot air blast at other people.**
- **Do not touch the metal nozzle as it becomes very hot during use and remains hot for up to 30 minutes after use.**
- **Do not place the nozzle against anything while using or immediately after use.**
- **Do not poke anything down the nozzle as it could give you an electric shock. Do not look down the nozzle while the unit is working because of the high temperature being produced.**
- **Do not allow paint to adhere to the nozzle or scraper as it could ignite after some time.**

Removing paint

- **Do not use this tool to remove paint containing lead. The peelings, residue and vapors of paint may contain lead, which is poisonous. Any pre-1960 building may have been painted in the past with paint containing lead and covered with additional layers of paint. Once deposited on surfaces, hand to mouth contact can result in the ingestion of lead. Exposure even to low levels of lead can cause irreversible damage to the brain and nervous system. Young and unborn children are particularly vulnerable.**
- **When removing paint, ensure that the work area is enclosed. Preferably wear a dust mask.**
- **Do not burn the paint. Use the scraper and keep the nozzle at least 25 mm away from the painted surface. When working in a vertical direction, work downwards to prevent paint from falling into the tool and burning.**
- **Dispose of all paint debris safely and ensure that the work area is thoroughly cleaned after completing the work.**

MOUNTING THE CORRECT ACCESSORY (IF APPLICABLE)

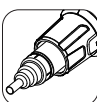
Icon	Description	Purpose
	Glass protection nozzle	Protection windows when stripping frames

Icon	Description	Purpose
	Reflector nozzle	Soldering pipes
	Reduction nozzle	Welding, sleeve shrinking (heat concentrated over small area)
	Wide-slot nozzle	Drying, thawing (heat spread over wider area)
	Overlap welding nozzle	Welding
	Solder sleeves reflector	Soldering
	Welding nozzle	Welding
	Pressure roller	Press the surface of working piece
	Scraper	Stripping paint and varnish



- Make sure that the tool is switched off and the nozzle has cooled down.
- Falling down nozzle may ignite objects on the floor. Nozzles must be mounted firmly and secure on the unit.
- Touching a hot nozzle can lead to serious burn. Before attaching or replacing a nozzle, allow the unit to cool down completely or use a suitable tool.
- A hot nozzle can set a surface on fire. Place down hot nozzles only on fire-proof surfaces.
- An incorrect or defective nozzle can lead to heat accumulation and damage the unit. Use only original nozzles according to the table that are suitable for your unit.

INSTRUCTIONS FOR USE



If you are not sure about the correct setting, start with a low temperature setting and gradually increase the temperature until you achieve optimum results.



Always observe the safety instructions and applicable regulations.



Use only one hand to hold the tool, do not place your other hand over the air vents.(Fig. 1)



Do not use the holes on the tool housing for the fall prevention purpose at high location.

Prior to operation

- Mount the correct accessory for the application.

Switching on and off

- Number of the slide switch means as follows.

HG6530V:

- 0: OFF position
- 1: For cooling down with approx. 50°C airflow
- 2: For heating with low air volume
- 3: For heating with high air volume

HG6531C:

- 0: OFF position
- 1: For cooling down with approx. 50°C airflow
- 2: For heating

- To switch the heat gun on, slide the slide switch (1) from 0 to one of the ON positions 1, 2 or 3.
- To switch off the heat gun, set the slide switch to position 1 to cool off for a while, and then set the slide switch to position 0 (OFF).



The heat gun may give off some smoke shortly after switching on. This does not indicate a problem with the device.

Setting the temperature (HG6530V)

The temperature can be set with the slide switch (1) at position 2 or 3.

- Press the temperature setting button + (2b) to increase the temperature, and - (2a) to decrease the temperature. The LCD (5) displays the present temperature of the airflow few seconds after the target temperature was set.
- To switch the unit of the temperature between °C or °F, press + and - together.

Selecting the preset mode (HG6531C)

14 preset modes are available to quickly set the temperature and air volume suitable for major applications. Select the desired preset application as follows.

1. Set the slide switch (1) at position 2. The LCD (5) displays the application name that was used at

the last time, and corresponding temperature and air volume settings. Few seconds later, the LCD displays the present temperature of the airflow.

2. Press the preset button (6). The application name starts to scroll.
3. Press the temperature setting buttons (2a/b) or air volume setting buttons (3a/b) to select the application. When the desired application name is displayed on the LCD, press the confirmation button (4) to decide it.



Whenever a setting is not confirmed by pressing the confirmation button (4) within 5-6 seconds, the device reverts to the previously confirmed setting.

Setting the temperature and air volume (HG6531C)

Change the temperature and air volume as follows. With the slide switch (1) at position 1, only the air volume can be changed.



With the slide switch at position 2, this procedure overwrites the preset temperature and air volume of the application currently displayed on the LCD.

1. Set the slide switch (1) at position 1 or 2.
2. Press the temperature setting buttons (2a/b) to change the temperature. Press the air volume setting buttons (3a/b) to change the air volume. The indications of temperature and air volume on the LCD (5) start to blink.
3. Press the confirmation button (4) to confirm the setting. The temperature and air volume on the LCD stop blinking. Few seconds later, the LCD displays the present temperature of the airflow.



Whenever a setting is not confirmed by pressing the confirmation button (4) within 5-6 seconds, the device reverts to the previously confirmed setting.

Setting the display language and temperature unit (HG6531C)

1. Set the slide switch (1) to position 1/2.
2. Press and hold the preset button (6) until the language bar blinks.
3. To switch the unit of the temperature between °C or °F, press the temperature setting buttons (2a/b). To change the language, press the air volume setting buttons (3a/b). 10 languages are available: English, German, Italian, French, Spanish, Portuguese, Dutch, Swedish, Chinese and Japanese.
4. Press the confirmation button (4) to decide your setting.

Detachable front cover

- The front cover can be removed when working at a narrow area.



Be careful of the hot nozzle. Removing the front cover increases the risk of burn with the bare hot nozzle.

Stripping paint

- Mount an appropriate accessory.
- Set a high air temperature.
- Switch the tool on.
- Direct the hot air onto the paint to be removed.
- When the paint softens, scrape the paint away using a hand scraper.



Do not strip metal window frames, as the heat may be conducted onto the glass and crack it. When stripping other window frames, use the glass protection nozzle.



Do not keep the tool directed at one spot too long to prevent igniting the surface.



Avoid collecting paint on the scraper accessory, as it may ignite. If necessary, carefully remove paint debris from the scraper accessory using a knife.

Stationary use

This tool can also be used in stationary mode.

- Place the tool onto a stable workbench.
- Secure the cable to prevent pulling the tool off the workbench.
- Carefully switch the tool on.



Make sure that the nozzle always points away from you and any bystanders.



Make sure not to drop anything into the nozzle.

Cooling down

The nozzle and accessory become very hot during use. Let them cool down before attempting to move or store the tool.

- To reduce the cooling time, switch the tool on at the lowest air temperature setting and let it run for a few minutes.
- Switch the tool off and let it cool down for at least 30 minutes. Always place it vertical and standing.



When the inside of heat gun gets too hot, the indication on the LCD blinks.

In that case, set the slide switch to position 1 to cool down the tool. After cooling down fully, restart the operation.

If the LCD still blinks after the restart, contact your local Makita Service Center.

MAINTENANCE AND CLEANING



Attention: Before performing any work on the equipment, pull the power plug.

Maintenance

- Your Power Tool has been designed to operate over a long period of time with a minimum of maintenance. Continuous satisfactory operation depends upon proper tool care and regular cleaning.

Lubrication

- Your power tool requires no additional lubrication.

Cleaning

- To prevent overheating of the motor, keep the ventilation slots of the machine clean and free from dust and dirt.
- Regularly clean the machine housing with a soft cloth, preferably after each use. If the dirt does not come off use a soft cloth moistened with soapy water.



Never use solvents such as petrol, alcohol, ammonia water, etc. These solvents may damage the plastic parts.

TECHNICAL DATA

Model No:	HG6531C	HG6530V
Voltage	220-240V~50/60Hz	220-240V~50/60Hz
Power	2000W	2000W
Temperature	I 50°C 200-550L/M	I 50°C 500L/M
Air flow	II 50-650°C 200-550L/M	II 50-650°C 280L/M
		III 50-650°C 550L/M
Overall length	257mm	257mm
Net weight	0.71kg	0.72kg

Default setting of the preset mode

No.	Application name	Temperature	Air volume
1	FREE SET 1	250°C	5
2	FREE SET 2	500°C	5
3	SCRINKING	300°C	3
4	FORMING	250°C	4
5	SOLDERING COPPER	650°C	3
6	DRYING PAINT	650°C	5
7	PAINT STRIPPING	450°C	5
8	WELDING FLOOR FOIL	450°C	3
9	WELDING PPEPDM	280°C	3
10	WELDING HDPE	300°C	3
11	WELDING PP	320°C	3
12	WELDING PVC-U	340°C	3
13	WELDING ABS	360°C	3
14	WELDING PC	380°C	3

ENVIRONMENT



Should your appliance need replacement after extended use, do not discard it with the household rubbish but dispose of it in an environmentally safe way.

Waste produced by electrical machine items should not be handled like normal household rubbish. Please recycle where facilities exist. Check with your Local Authority or retailer for recycling advice.

Subject to change without notice.

警告

儿童或身体、感官或心智能力降低或者缺乏相关经验和知识的人士不可使用本设备。请勿让儿童玩耍本设备。请勿让儿童清洁和维护本设备。

如果电源线损坏，请务必请制造商、维修代理或类似的专业人员更换，以免发生危险。

如果未小心使用设备，可能导致起火，因此：

- 在有易燃材料的地方使用设备时，请小心；
- 不要在同一地方长时间使用；
- 不要在易爆环境下使用；
- 请注意可能会传热到视线外的易燃材料；
- 使用后，将设备放在支架上并在贮存之前让它冷却；
- 当设备开启时，不要让它无人看管。

预期用途

热风枪设计用于剥漆、焊接管道、收缩PVC、焊接和弯曲塑料以及一般干燥和解冻用途。



警告：使用设备之前，为了确保自身安全，请仔细阅读本手册和一般安全说明。你的电动工具只能与这些说明书一起传递。



该工具只应连接到具有铭牌上所示的相同电压的电源，且只能采用单相交流电源供电。它们采用双重绝缘，因此，可用于不配备接地线的插座。



热表面 - 灼伤手指或双手。

描述

1. 滑动开关
2. 温度设置按钮 (2a -、2b+)
3. 风量设置按钮 (3a -、3b +)
4. 确认按钮
5. LCD
6. 预设按钮
7. 进风口
8. 前盖
9. 喷嘴

包装内容清单

- 检查设备、电源线、电源插头和所有附件是否存在运输损坏。



警告：包装材料不是玩具！切勿让儿童玩耍塑料袋！存在窒息危险！

- 1 个热风枪
- 1 套附件（可能不一定要包括附件）
- 1 本说明手册



当部件缺失或损坏时，请联系你的经销商。

电动工具通用安全警告

阅读随电动工具提供的所有安全警告、说明、图示和规定。不遵照以下所列说明会导致电击、着火和 / 或严重伤害。

保存所有警告和说明书以备查阅。

警告中的术语“电动工具”是指市电驱动（有线）电动工具或电池驱动（无线）电动工具。

工作场地的安全

1. 保持工作场地清洁和明亮。杂乱和黑暗

的场地会引发事故。

2. 不要在易爆环境，如有易燃液体、气体或粉尘的环境下操作电动工具。电动工具产生的火花会点燃粉尘或气体。
3. 操作电动工具时，远离儿童和旁观者。注意力不集中会使你失去对工具的控制。

电气安全

1. 电动工具插头必须与插座相配。绝不能以任何方式改装插头。需接地的电动工具不能使用任何转换插头。未经改装的插头和相配的插座将降低电击风险。
2. 避免人体接触接地表面，如管道、散热片和冰箱。如果你身体接触接地表面会增加电击风险。
3. 不得将电动工具暴露在雨中或潮湿环境中。水进入电动工具将增加电击风险。
4. 不得滥用软线。绝不能用软线搬运、拉动电动工具或拔出其插头。使软线远离热源、油、锐边或运动部件。受损或缠绕的软线会增加电击风险。
5. 当在户外使用电动工具时，使用适合户外使用的延长线。适合户外使用的电线将降低电击风险。
6. 如果无法避免在潮湿环境中操作电动工具，应使用带有剩余电流装置（RCD）保护的电源。RCD的使用可降低电击风险。
7. 始终建议通过额定剩余电流为30 mA或以下的RCD来使用电源。
8. 电动工具会产生对用户无害的电磁场（EMF）。但是，起搏器和其他类似医疗设备的用户应在操作本电动工具前咨询其设备的制造商和 / 或医生寻求建议。
9. 请勿用湿手触摸电源插头。
10. 如果导线破损，则由制造商或其代理商更换以避免安全隐患。

人身安全

1. 保持警觉，当操作电动工具时关注所从事的操作并保持清醒。当你感到疲倦，或在有药物、酒精或治疗反应时，不要操作电动工具。在操作电动工具时瞬间的疏忽会导致严重人身伤害。
2. 使用个人防护装置。始终佩戴护目镜。防护装置，诸如适当条件下使用防尘面具、防滑安全鞋、安全帽、听力防护等装置能减少人身伤害。
3. 防止意外起动。在连接电源和/或电池包、拿起或搬运工具前确保开关处于关

断位置。手指放在开关上搬运工具或开关处于接通时通电会导致危险。

4. 在电动工具接通之前，拿掉所有调节钥匙或扳手。遗留在电动工具旋转零件上的扳手或钥匙会导致人身伤害。
5. 手不要过分伸展。时刻注意立足点和身体平衡。这样能在意外情况下能更好地控制住电动工具。
6. 着装适当。不要穿宽松衣服或佩戴饰品。让你的头发和衣服远离运动部件。宽松衣服、佩饰或长发可能会卷入运动部件。
7. 如果提供了与排屑、集尘设备连接用的装置，要确保其连接完好且使用得当。使用集尘装置可降低尘屑引起的危险。
8. 不要因为频繁使用工具而产生的熟悉感而掉以轻心，忽视工具的安全准则。某个粗心的动作可能在瞬间导致严重的伤害。
9. 使用电动工具时请始终佩带护目镜以免伤害眼睛。护目镜须符合美国ANSI Z87.1、欧洲EN 166或者澳大利亚 / 新西兰的AS/NZS 1336的规定。在澳大利亚 / 新西兰，法律要求佩带面罩保护脸部。

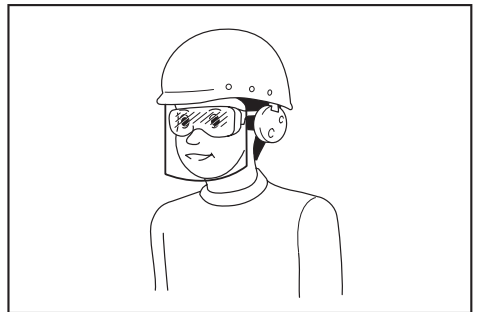

雇主有责任监督工具操作者和其他近工作区域人员佩带合适的安全防护设备。

电动工具使用和注意事项

1. 不要勉强使用电动工具，根据用途使用合适的电动工具。选用合适的按照额定值设计的电动工具会使你工作更有效、更安全。
2. 如果开关不能接通或关断电源，则不能使用该电动工具。不能通过开关来控制的电动工具是危险的且必须进行修理。
3. 在进行任何调节、更换附件或贮存电动工具之前，必须从电源上拔掉插头和/或卸下电池包（如可拆卸）。这种防护性的安全措施降低了电动工具意外起动的

风险。

- 将闲置不用的电动工具贮存在儿童所及范围之外，并且不允许不熟悉电动工具和不了解这些说明的人操作电动工具。电动工具在未经培训的使用者手中是危险的。
- 维护电动工具及其附件。检查运动部件是否调整到位或卡住，检查零件破损情况和影响电动工具运行的其他状况。如有损坏，应在使用前修理好电动工具。许多事故是由维护不良的电动工具引发的。
- 保持切削刀具锋利和清洁。维护良好的有锋利切削刃的刀具不易卡住而且容易控制。
- 按照使用说明书，并考虑作业条件和要进行的作业来选择电动工具、附件和工具的刀头等。将电动工具用于那些与其用途不符的操作可能会导致危险情况。
- 保持手柄和握持表面干燥、清洁，不得沾有油脂。在意外的情况下，湿滑的手柄不能保证握持的安全和对工具的控制。
- 使用本工具时，请勿佩戴可能会缠结的布质工作手套。布质工作手套卷入移动部件可能会造成人身伤害。

维修

- 由专业维修人员使用相同的备件维修电动工具。这将保证所维修的电动工具的安全。
- 上润滑油及更换附件时请遵循本说明书指示。

热风枪的附加安全说明

- 不要将手放在通风口或以任何方式堵塞通风口。
- 在使用过程中，该工具的喷嘴和附件变得非常热。触摸之前，请让这些部件冷却。
- 将工具放下之前，务必将它关闭。
- 当工具开启时，不要让它无人看管。

- 如果未小心使用设备，可能导致起火。
- 可能会传热到视线外的易燃材料。请勿在可能有易燃气体或靠近易燃材料的潮湿环境中使用。
- 让工具在贮存之前完全冷却。
- 确保通风良好，因为可能会产生有毒烟雾。
- 请勿用作吹风机。
- 不要堵塞进气口或喷嘴出口，因为可能会导致积聚过多的热量，从而造成工具损坏。
- 不要将热气流吹向他人。
- 请勿触摸金属喷嘴，因为在使用过程中它会变得很热并在使用后保持灼热长达 30 分钟。
- 在使用时或使用后不要立即将喷嘴放在任何物体上。
- 不要戳中喷嘴下方的任何物体，因为可能会使你遭到电击。在装置工作时不要俯看喷嘴，因为会产生高温。
- 不要让油漆粘附在喷嘴或刮刀上，因为它可能在一段时间后点燃。

除漆

- 请勿使用该工具去除含铅的油漆。油漆剥皮、残留物和蒸汽可能含有有毒的铅。任何 1960 年之前的建筑可能在过去涂有包含铅的油漆，并覆盖附加涂层。沉积在表面后，手嘴接触会导致摄入铅。即使接触低含量的铅也会对人体和神经系统造成不可逆转损害。年幼和未出生的孩子特别脆弱。
- 除漆时，确保封闭工作场地。最好佩戴防尘面具。
- 不要点燃油漆。使用刮刀并使喷嘴距漆面至少 25 mm。在垂直方向工作时，向下作业以防油漆落入工具并燃烧。
- 安全处理所有油漆碎片并确保在完成工作后彻底清洁工作场地。

安装正确的附件（如适用）

图标	描述	用途
	玻璃防护喷嘴	剥离框架时保护窗户

图标	描述	用途
	钩	焊接管道
	圆嘴	焊接、收缩套管（热量集中在小区域上）
	扁嘴	吹干、解冻（热量扩散到更宽区域上）
	塔形扁嘴	焊接
	塔形缺口扁嘴	焊接
	塔形焊接喷嘴	焊接
	滚轮	按压工件的表面
	刮刀	剥离油漆和清漆



- 确保工具已关闭且喷嘴已冷却。
- 喷嘴跌落可能会点燃地面上的物体。喷嘴必须牢固地安装并固定在装置上。
- 触摸热喷嘴可能导致严重灼伤。在连接或更换喷嘴之前，请让装置完全冷却或使用适当的工具。
- 热喷嘴可能会使表面起火。仅可将热喷嘴放在防火表面上。
- 喷嘴不正确或有缺陷可能会导致热量积聚并损坏装置。根据表格，仅使用适用于你装置的原装喷嘴。

使用说明



如果你不确定正确的设置，请从低温设置开始，然后逐渐增加温度直至达到最佳结果。



始终遵守安全说明和适用的法规。



仅使用一只手握住工具，不要将另一只手放在通风口。（图 1）



不要在高处使用工具外壳上的孔来防止坠落。

开始操作前

- 根据应用安装正确的附件。

开启和关闭

- 滑动开关的编号含义如下。

HG6530V:

- 0：OFF 位置
- 1：用约 50°C 的气流冷却
- 2：低风量加热
- 3：高风量加热

HG6531C:

- 0：OFF 位置
- 1：用约 50°C 的气流冷却
- 2：加热

- 要开启热风枪，请将滑动开关 (1) 从 0 滑动到 ON 位置 1、2 或 3 之一。
- 要关闭热风枪，请将滑动开关设置在位置 1 冷却一会，然后将滑动开关设置在位置 0 (OFF)。



热风枪开启后不久可能会冒出一些烟雾。这并非表示装置有问题。

设置温度 (HG6530V)

可以将滑动开关 (1) 设置在位置 2 或 3 来设置温度。

- 按下温度设置按钮 + (2b) 可提高温度，按下 - (2a) 可降低温度。设置目标温度后几秒，LCD (5) 会显示目前的气流温度。
- 要在 °C 或 °F 之间切换温度单位，请一起按下 + 和 -。

选择预设模式 (HG6531C)

共提供 14 种预设模式，可快速设置适合主要应用的温度和风量。选择所需的预设应用如下。

1. 将滑动开关 (1) 设置在位置 2。LCD (5) 会显示上次使用的应用名称以及相应的温度和风量设置。几秒后，LCD 将显示目前的气流温度。
2. 按下预设按钮 (6)。应用名称开始滚动。
3. 按下温度设置按钮 (2a/b) 或风量设置按钮 (3a/b) 以选择应用。当 LCD 上显示所需的应用名称时，按下确认按钮 (4) 确定。



在 5-6 秒内未按下确认按钮 (4) 来确认设置时，装置将恢复到先前确认的设置。

设置温度和风量 (HG6531C)

更改温度和风量如下。当滑动开关 (1) 处于位置 1 时，只能更改风量。



当滑动开关处于位置 2 时，此操作将覆盖当前 LCD 上所显示应用的预设温度和风量。

1. 将滑动开关 (1) 设置在位置 1 或 1/2。
2. 按下温度设置按钮 (2a/b) 可更改温度。按下风量设置按钮 (3a/b) 可更改风量。LCD (5) 上的温度和风量指示开始闪烁。
3. 按下确认按钮 (4) 以确认设置。LCD 上的温度和风量指示停止闪烁。几秒后，LCD 将显示目前的气流温度。



在 5-6 秒内未按下确认按钮 (4) 来确认设置时，装置将恢复到先前确认的设置。

设置显示语言和温度单位 (HG6531C)

1. 将滑动开关 (1) 设置在位置 1/2。
2. 按住预设按钮 (6) 直至语言栏闪烁。
3. 要在 °C 或 °F 之间切换温度单位，请按温度设置按钮 (2a/b)。要更改语言，请按风量设置按钮 (3a/b)。提供 10 种语言选项：英语、德语、意大利语、法语、西班牙语、葡萄牙语、荷兰语、瑞典语、中文和日语。
4. 按下确认按钮 (4) 以确定设置。

可拆卸前盖

- 在狭窄区域中工作时，可以取下前盖。



小心热喷嘴。
取下前盖会增加裸露热喷嘴造成灼伤的危险。

剥漆

- 安装适当的附件。

- 设置较高空气温度。
- 开启工具。
- 将热气指向要去掉的油漆。
- 当油漆软化时，使用手动刮刀刮下油漆。



请勿剥离金属窗框，因为可能会传热到玻璃上，使其破裂。剥离其他窗框时，请使用玻璃防护喷嘴。



请勿将工具长时间指向一个点以防点燃表面。



避免收集刮刀附件上的油漆，因为它可能会点燃。必要时，使用小刀从刮刀附件上小心去除油漆碎片。

固定使用

该工具还可用于固定模式。

- 将工具放在稳定的工作台上。
- 固定电缆以防从工作台上拉掉工具。
- 小心开启工具。



确保喷嘴始终远离你和任何旁观者。



确保不要将任何东西掉入喷嘴。

冷却

在使用过程中，喷嘴和附件会变得非常热。在尝试移动或贮存工具之前，请让它们冷却。

- 要降低冷却时间，请在最低空气温度设置下开启工具并让它运行几分钟。
- 关闭工具，然后让它冷却至少30分钟。始终垂直放置工具。



热风枪内部温度过高时，LCD 指示灯会闪烁。

这种情况下，请将滑动开关拨至位置 **1**，以冷却工具。工具完全冷却后，重新开始操作。

如果重新启动后 **LCD** 仍然闪烁，请联系当地牧田公司服务中心。

维护和清洁



注意：对设备执行任何工作之前，请拉动电源插头。

维护

- 你的电动工具可长时间运行，所需维护

极少。持续满意的操作取决于适当的工具维护和定期清洁。

润滑

- 你的电动工具无需额外的润滑。

清洁

- 为防止电机过热，请保持机器的通风槽干净且没有灰尘和污垢。
- 使用软布定期清洁机器外壳，最好是每次使用后清洁。如果污垢未脱落，请使用蘸有肥皂水的软布清洁。



切勿使用诸如汽油、酒精、氨水等溶剂。这些溶剂可能会损坏塑料部件。

技术数据

型号：	HG6531C	HG6530V
电压	220V~50Hz	220V~50Hz
功率	2000W	2000W
温度 风量	I 50°C 200-550L/M II 50-650°C 200-550L/M	I 50°C 500L/M II 50-650°C 280L/M III 50-650°C 550L/M
总长度	257mm	257mm
净重	0.71kg	0.72kg

预设模式的默认设置

编号	应用名称	温度	风量
1	普通模式 1	250°C	5
2	普通模式 2	500°C	5
3	收缩	300°C	3
4	成形	250°C	4
5	焊接铜	650°C	3
6	干燥涂装	650°C	5
7	涂装脱模	450°C	5
8	焊接地板箔	450°C	3
9	焊接 PPEPDM	280°C	3
10	焊接 HDPE	300°C	3
11	焊接 PP	320°C	3
12	焊接 PVC-U	340°C	3
13	焊接 ABS	360°C	3
14	焊接 PC	380°C	3

环保



如果你的设备在长时间使用后需要更换，请勿与家庭垃圾一同丢弃，而是以安全环保的方式进行处理。

由电气设备产品产生的废物不应按普通的家庭垃圾一样处理。请在提供设施的地方进行回收。有关回收建议，请咨询您的当地机构或零售商。

如有变更，恕不另行通知。

警告

兒童或身體、感官或精神能力低弱或缺乏經驗與知識之人，不得使用本電氣用具。兒童不得把玩本電氣用具。兒童不得進行清潔和使用者維護。

如果電源線損壞，必須由製造商、其服務代理商或類似的合格人員更換，以避免危險。

若未小心使用本電氣用具，可能會導致火災，因此：

- 請多加注意，不要在具有可燃材料之處使用此電氣用具；
- 請勿長時間針對同一個定點使用工具；
- 請勿在容易爆炸的環境中使用；
- 請注意，熱能可能會傳導至看不見的可燃材料；
- 使用電氣用具後，在存放之前請先將其置於座架上等待冷卻；
- 在啟動電源之後，請勿讓電氣用具處於無人看管的狀態。

預定用途

您的電子式熱風槍是設計用於剝離漆料、焊接管路、收縮 PVC、焊接和彎折塑料，以及一般的烘乾和解凍。



警告：爲了您的安全起見，在使用這些電氣用具前，請詳細閱讀本手冊與一般安全須知。在交接電動工具時亦應隨附這些說明。



工具應連接至與銘牌所示電壓相同的電源供應器，而且只能透過單相交流電源的供電運作。這些工具採用雙層絕緣，因此也可連接無接地線的插座使用。



表面高溫 - 手指或手部灼傷。

說明

1. 滑動開關
2. 溫度設定按鈕 (2a -、2b +)
3. 風量設定按鈕 (3a -、3b +)
4. 確認按鈕
5. LCD
6. 預設按鈕
7. 進風口
8. 前蓋
9. 噴嘴

包裝內容物清單

- 請檢查電氣用具、電源線、電源插頭和所有配件是否在運送時損壞。



警告：包材不是玩具！絕對不能讓兒童把玩塑膠袋！會有造成窒息的危險！

- 1 支電子式熱風槍
- 1 組配件 (配件不一定會隨附)
- 1 份使用說明書



如果有遺漏或損壞的零件，請和您的經銷商聯絡。

一般電動工具安全警告

請通讀本電動工具附帶的所有安全警告、安全事項、插圖和規格。未按照以下列舉安全事項而使用或操作可能導致觸電、火災和/或嚴重傷害。

妥善保存所有的警告和安全事項說明以備將來參考。

在該警告中的「電動工具」是指電網電源供電（接電源線）的電動工具或電池驅動（充電式）的電動工具。

工作場地安全

1. 保持工作場地清潔和明亮。混亂和黑暗的場所會引發事故。
2. 請勿在易燃環境，如有易燃液體、氣體或粉塵的環境下操作電動工具。電動工具產生的火花會點燃粉塵或氣體。
3. 操縱電動工具時不可讓兒童和旁觀者接近。操作時分心會使你無法正常控制機器。

電氣安全

1. 電動工具插頭必須與插座匹配。絕不能以任何方式改裝插頭。需接地的電動工具不能使用任何轉換插頭。使用未經改裝的插頭和與之匹配的插座將減少

觸電危險。

2. 工作時，身體不可接觸到接地的金屬體，例如鐵管、散熱器、火爐和冷凍機。如果身體接地會增加觸電危險。
3. 不得將電動工具暴露在雨中或潮濕環境中。若有水進入電動工具將增加觸電危險。
4. 不得踏踏導線。不可拖著導線移行工具或拉導線拔出插頭。選須避免使導線觸及高熱物體、油脂、尖銳邊緣或運動部件。受損或纏繞的導線會增加觸電危險。
5. 當在戶外使用電動工具時，一定要採用戶外專用的延長導線。採用戶外專用的延長導線能減少觸電的危險。
6. 如必須在潮濕的環境中使用電動工具，請使用殘餘電流裝置（RCD）保護電源。使用RCD保護電源能減少觸電的危險。
7. 建議使用為電源配備額定殘餘電流為30 mA以下的RCD保護裝置。
8. 電動工具會產生對使用者無害的電磁場（EMF）。不過，對心律調整器使用者及其他類似醫療器材的使用者而言，請務必先聯絡器材製造商及／或醫師以瞭解相關建議，再操作此類電動工具。
9. 請勿用濕手直接觸碰電源插頭。
10. 若線材損壞，請交由製造商或其代理商更換，以確保使用安全。

人身安全

1. 保持警覺，當操作電動工具時關注所從事的操作並保持清醒。請勿在疲勞時或受到藥物、酒精或治療影響時操作電動工具。在操作電動工具期間分心可能會導致嚴重人身傷害。
2. 使用安全裝置。始終佩戴護目鏡。安全裝置，如適當條件下的防塵面具、防滑安全鞋、安全帽、防護耳罩等設備能減少人身傷害。
3. 避免意外起動。在將工具接上電源和／或電池組以及拿起或搬動電動工具之前，確保開關處於關閉位置。搬運工具時手指放在已接通電源的開關上或開關處於接通時插入插頭可能會引發事故。
4. 在電動工具接通之前，取下所有調節鑰匙或扳手。遺留在電動工具旋轉零件上的扳手或鑰匙會導致人身傷害。
5. 操作時手不要伸得太長。使用時請雙腳站穩，時刻保持平衡。這樣在意外情況下能很好地控制電動工具。
6. 注意衣裝。不要穿寬鬆衣服或佩帶飾品。勿使頭髮和衣服靠近運動部件。寬鬆衣服、佩飾或長發易卷入運動部件。
7. 如果提供了與排屑裝置、集塵設備連接用的裝置，則確保它們連接完好且使用得當。使用集塵設備可減少因碎屑引起的危險。
8. 切勿因頻繁使用本工具而自認熟練導致您大意輕忽工具的安全原則。一時的疏忽隨即會造成人員重傷。
9. 使用電動工具時，請務必配戴護目鏡，以防眼睛受到傷害。護目鏡需符合美國 ANSI Z87.1 標準、歐洲 EN 166 標準或澳洲／紐西蘭 AS/NZS 1336 標準。若於澳洲／紐西蘭地區，法定需配戴面罩以保護臉部。

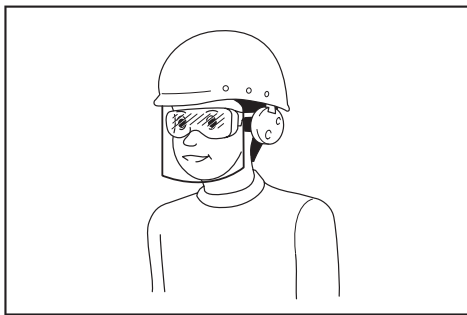

雇主有責任監督工具操作者和其他鄰近工作區域的人員穿戴合適的安全保護裝備。

電動工具使用和注意事項

1. 使用電動工具時請勿用蠻力。根據用途使用適當的電動工具。選擇具有適當設計額定值的電動工具會使妳工作更有效、更安全。
2. 如果開關無法接通或關閉工具電源，則不可使用該電動工具。不能用開關來控制的電動工具是危險的且必須進行修理。
3. 在進行任何調整、更換配件或存放電動工具之前，請將插頭從電源上拔下，並且／或將可拆式電池組從工具上取下。此類防護性安全措施可減少電動工具突然起動的危險。
4. 將閒置的電動工具存放在小孩不能拿到之處，並且不要讓不熟悉電動工具或對這些說明不了解的人操作電動工具。電動工具在未經訓練的用戶手中是危險的。
5. 保養電動工具及配件。檢查可移動的部份的對位偏差或卡滯、零件破損情況和影響電動工具運轉的其他條件。如有損壞，電動工具必須在使用之前修理好。許多事故由保養不良的電動工具引發。
6. 保持切削刀具的鋒利和清潔。保養良好的有鋒利切削刃的刀具不易被卡住且容易控制。
7. 按照使用說明書，根據作業條件和作業特點來使用電動工具、附件和工具的刀頭等。將電動工具用於那些與要求不符的操作可能會導致危險情況。
8. 手柄及握把表面務必保持乾燥清潔，不沾油脂。如手柄及握把表面油滑，將無法在非預期的情況下安全操控工具。
9. 使用此工具時，請勿穿戴可能會捲入的布質工作手套。布質工作手套捲入移動零件中，會導致嚴重的人身傷害。

維修

1. 將你的電動工具送交專業維修人員修理，必須使用相同的備件進行更換。這樣將確保所維修的電動工具的安全性。
2. 上潤滑油及更換附件時請遵循本說明書指示。

電子式熱風槍的其他安全指示

- 請勿將您的手放在通風口上，或是以任何方式擋住通風口。
- 本工具的噴嘴和配件在使用時會變得極熱，請先讓這些零件冷卻後再觸碰。
- 將工具放下之前，請務必將其電源關閉。
- 電源開啓時，請勿讓工具處於無人看管的狀態。
- 若未小心使用本電氣用具，可能會導致火災。
- 熱能可能會傳導至看不見的可燃材料。請勿在潮濕的環境使用，其中可能會存在易燃氣體或靠近







可燃材料。



- 存放前請先讓工具完全冷卻。
- 請務必保持適當的通風，因為作業的過程中可能會產生有毒氣體。
- 請勿使用吹風機。
- 請勿擋住進氣口或噴嘴出風口，此行為可能會造成過多的熱能累積，而使工具受損。
- 請勿將熱風朝著別人身上吹動。
- 請勿觸碰金屬噴嘴，因為在使用時和使用過後 30 分鐘內，噴嘴都會處於高溫狀態。
- 使用時或剛使用完後，請勿將噴嘴靠在任何物體上。
- 請勿用任何物體戳進噴嘴，因為您可能會觸電，電子式熱風槍正在運作時請勿鎖住噴嘴，因為會產生高溫。
- 請勿讓漆料黏附在噴嘴或刮刀上，否則過一段時間可能會點燃。

去除漆料

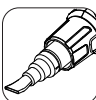
- 請勿使用此工具來去除含鉛的漆料。漆料的剝落物、殘餘碎屑和蒸氣可能會包含具毒性的鉛。1960 年之前所蓋的所有建物，過去在粉刷時可能使用了含鉛的漆料，然後上方再塗覆其他層的漆料。這種含鉛漆料一旦沉積於表面，手到口的接觸可能會導致鉛的攝入。即使僅暴露於少量的含鉛環境中，都會對大腦和神經系統造成無法逆轉的傷害。幼兒和胎兒尤其容易受到影響。
- 進行去除漆料的作業時，請務必將工作區域圍起。最好戴上防塵口罩。
- 請勿讓漆料燒起來。使用刮刀，並讓噴嘴距離漆面至少 25 mm。以垂直方向作業時，請由上往下進行，避免漆料掉進工具而燃燒。
- 完成工作後，請安全地處理所有漆料碎片，並務必將工作區域完全清掃乾淨。

安裝正確的配件 (如適用)

圖示	說明	用途
	玻璃保護噴嘴	在剝除窗框時保護窗戶
	鉤	焊接管路
	圓嘴	焊接、套管收縮 (熱氣集中於小範圍)
	扁嘴	烘乾、解凍 (熱氣可散佈到更廣的範圍)
	塔形扁嘴	焊接
	塔形缺口扁嘴	軟焊

圖示	說明	用途
	塔形焊接噴嘴	焊接
	滾輪	按壓工件的表面
	刮刀	剝除油漆與清漆



- 請確定關閉工具的電源，且噴嘴已冷卻。
- 讓噴嘴掉落可能會點燃地板上的物體。噴嘴必須牢固地安裝於裝置上。
- 觸碰高熱的噴嘴可能會導致嚴重燙傷。在安裝或更換噴嘴之前，請先讓裝置完全冷卻，或使用適合的工具。
- 高熱的噴嘴可能會使表面著火。請只將高熱的噴嘴放置於防火表面上。
- 規格不符或故障的噴嘴可能會造成積熱並使裝置損壞。請根據表格只使用適合您裝置的原廠噴嘴。

使用說明



如果您不確定正確的設定為何，請從低溫設定開始，然後逐漸地增加溫度，直到達成最理想的效果為止。



請務必遵循安全指示和適用的規範。



請只用一隻手來握住工具，不要將另一隻手放在通風口上。(圖 1)



為預防從高處掉落，請勿使用工具外殼上的孔。

操作前

- 根據應用安裝正確的配件。

切換開啓和關閉

- 滑動開關的數字代表下列意義。

HG6530V：

- 0：關閉位置
- 1：使用約 50°C 的氣流冷卻
- 2：使用低風量加熱
- 3：使用高風量加熱

HG6531C：

- 0：關閉位置
- 1：使用約 50°C 的氣流冷卻
- 2：用於加熱

- 若要開啓熱風槍，請將滑動開關 (1) 從 0 滑動到開

啓位置 1、2 或 3 的其中一個位置。

- 若要關閉熱風槍，請將滑動開關設定為位置 1 冷卻一段時間，然後將滑動開關設定為位置 0 (關閉)。



開啓後不久，熱風槍可能會排放一些煙霧。這並非表示裝置出現問題。

設定溫度 (HG6530V)

將滑動開關 (1) 設定於位置 2 或 3 可設定溫度。

- 按下溫度設定按鈕 + (2b) 可提高溫度，按下 - (2a) 可降低溫度。設定目標溫度後幾秒內，LCD (5) 會顯示目前的氣流溫度。
- 若要在 °C 或 °F 之間切換溫度單位，請同時按下 + 和 -。

選取預設模式 (HG6531C)

14 個預設模式可用於快速設定主要應用適合的溫度和風量。如下所示，選取所要的預設應用。

1. 將滑動開關 (1) 設定於位置 2。LCD (5) 會顯示上次使用的應用名稱，以及對應的溫度和風量設定。幾秒鐘後，LCD 會顯示目前的氣流溫度。
2. 按下預設按鈕 (6)。應用名稱開始捲動。
3. 按下溫度設定按鈕 (2a/b) 或風量設定按鈕 (3a/b) 選取應用。LCD 顯示所要的應用名稱時，按下確認按鈕 (4) 決定使用。



按下確認按鈕 (4) 而未在 5 至 6 秒內確認設定時，裝置將恢復到先前確認的設定。

設定溫度和風量 (HG6531C)

如下所示，變更溫度和風量。滑動開關 (1) 在位置 1 時，僅可變更風量。



滑動開關在位置 2 時，此程序會覆蓋 LCD 目前顯示之應用的預設溫度和風量。

1. 將滑動開關 (1) 設定於位置 1 或 2。
2. 按下溫度設定按鈕 (2a/b) 變更溫度。按下風量設定按鈕 (3a/b) 變更風量。LCD (5) 指示的溫度和風量開始閃爍。
3. 按下確認按鈕 (4) 確認設定。LCD 上的溫度和風量停止閃爍。幾秒鐘後，LCD 會顯示目前的氣流溫度。



按下確認按鈕 (4) 而未在 5 至 6 秒內確認設定時，裝置將恢復到先前確認的設定。

設定顯示語言和溫度單位 (HG6531C)

1. 將滑動開關 (1) 設定為位置 1/2。
2. 按住預設按鈕 (6) 直到語言列閃爍。
3. 若要在 °C 或 °F 之間切換溫度單位，請按下溫度設定按鈕 (2a/b)。若要變更語言，請按下風量設定按鈕 (3a/b)。有 10 種語言可用：英語、德語、義大利語、法語、西班牙語、葡萄牙語、荷蘭語、瑞典語、中文和日語。
4. 按下確認按鈕 (4) 決定設定。

可拆式前蓋

- 針對狹窄範圍進行作業時，可拆除前蓋。



請小心高熱的噴嘴。
移除前蓋會增加被裸露的高熱噴嘴燙傷的風險。

剝除漆料

- 安裝適合的配件。
- 設定高風溫。
- 開啓工具的電源。
- 將熱風朝著要去掉的漆料吹。
- 當漆料軟化時，使用手刮刀來將漆料刮除。



不要用來剝除金屬窗框，因為熱能可能會傳導至玻璃而使其碎裂。剝除其他種類的窗框時，請使用玻璃保護噴嘴。



不要將工具朝向定點太久，以免點燃表面。



避免讓漆料積聚在刮刀配件上，否則可能會點燃。如有必要，請用刀片小心地將刮刀上的漆料碎片去除。

台式使用

本工具也可以在台式模式下使用。

- 將工具放在穩定的工作台上。
- 固定連接線，以防止連接線將工具拉下台面。
- 小心地開啓工具的電源。



請務必將噴嘴的方向遠離您自身和任何旁觀者。



請務必不要讓任何物體掉入噴嘴。

冷卻

噴嘴和配件在使用時會變得極熱。在移動或存放工具之前，請先讓工具冷卻。

- 若要縮短冷卻時間，請以最低風溫的設定開啓工具的電源，然後讓工具運轉幾分鐘。
- 關閉工具的電源，然後讓工具冷卻至少 30 分鐘。請一律將工具以垂直站立的方式放置。



熱風槍內部過熱時，LCD 的指示燈會閃爍。

在這種情況下，將滑動開關設定到位置 1 可冷卻工具。完全冷卻後，重新開始作業。

重新開始後，如果 LCD 仍然閃爍，請洽詢當地的牧田服務中心。

維護與清潔



請注意：在對設備進行任何動作之前，請先拔起電源插頭。

維護

- 這些電動工具的設計，可在最低的維護下長時間運作。是否能夠持續維持理想的運作狀態，取決於適當的工具保養和定期清潔。

潤滑

- 電動工具不需額外的潤滑。

清潔

- 為避免馬達過熱，請保持機器通風孔的清潔，避免積聚灰塵和污垢。
- 定期使用軟布來清潔機器的外殼，最好是在每次使用之後進行。如果有灰塵堆積在上面，請使用以肥皂水沾濕的軟布來清潔。



切勿使用汽油、酒精和氨水等溶劑，這些溶劑可能會損壞塑膠零件。

技術資料

型號：	HG6531C	HG6530V
電壓	110V~60Hz	110V~60Hz
電力	1400W	1400W
溫度	I 50°C	I 50°C
氣流量	150-450L/M	400L/M
	II 50-650°C*	150-450L/M
		II 50-650°C* 230L/M
		III 50-650°C* 450L/M
總長	257mm	257mm
淨重	0.71kg	0.72kg

*備註：只有配合扁嘴、塔形扁嘴或塔形焊接噴嘴使用時，方可達到 650°C 出風溫度。

預設模式的預設設定

編號	應用名稱	溫度	風量
1	普通模式 1	250°C	5
2	普通模式 2	500°C	5
3	收縮	300°C	3
4	成形	250°C	4
5	焊接鋼	650°C	3
6	乾燥塗裝	650°C	5
7	塗裝脫模	450°C	5

編號	應用名稱	溫度	風量
8	焊接地板箔	450°C	3
9	焊接 PPEPDM	280°C	3
10	焊接 HDPE	300°C	3
11	焊接 PP	320°C	3
12	焊接 PVC-U	340°C	3
13	焊接 ABS	360°C	3
14	焊接 PC	380°C	3

環保



如果您的電氣用具在長期使用後需要更換，請勿隨家用垃圾丟棄，而是以不會對環境造成傷害的方式處理。

電氣機器用具所產生的廢棄物，不應以一般家用垃圾的方式棄置。請送到回收設施回收。關於回收的建議，請洽詢您當地的主管機關或零售業者。

如有變更，恕不另行通知。

台湾RoHS限用物质含有量标示
 请扫描右方QR Code或参考下列网址；
<https://makita.com.tw/rohs/>



生产制造商名称：Makita Corporation
 进口商名称：台湾牧田股份有限公司

电话：02-8601-9898 传真机：02-8601-2266
 地址：新北市24459 林口区文化三路二段 798 号

www.makita.com

⚠ 경고

이 기기는 어린이, 신체, 감각 또는 지적 능력에 장애가 있는 사람 또는 사용 경험과 지식이 부족한 사람이 사용할 수 없습니다. 어린이가 이 기기를 가지고 놀지 않게 하십시오. 어린이가 이 기기를 청소하거나 유지 관리해서는 안 됩니다.

전선이 손상된 경우에는 위험을 방지하기 위해 반드시 제조업체, 서비스 센터 직원 또는 유사한 자격을 갖춘 사람이 교체해야 합니다.

기기를 주의해서 사용하지 않으면 화재가 발생할 수 있으므로 다음 사항을 유의하십시오.

- 기기를 가연성 물질이 있는 곳에서 사용할 때 주의하십시오.
- 같은 위치에 장시간 사용하지 마십시오.
- 폭발 위험이 있는 환경에서 사용하지 마십시오.
- 보이지 않는 곳에 있는 가연성 물질에 열이 전도될 수 있다는 점을 명심하십시오.
- 기기 사용 후 전용 거치대에 올려 두고 열이 완전히 식은 후에 보관하십시오.
- 기기를 스위치가 켜진 상태로 두고 자리를 비우지 마십시오.

용도

이 열풍기는 일반적인 건조 및 해빙 용도를 비롯하여 페인트 제거, 파이프 납땜, PVC 수축, 플라스틱 응접 및 밴딩 용도로 제작되었습니다.



경고: 안전한 사용을 위해 기기를 사용하기 전에 이 설명서와 일반 안전 지침을 주의 깊게 읽어주십시오. 전동공구 양도 시 이러한 문서도 함께 양도해야 합니다.



공구를 명판에 명시된 전압의 전원에만 연결해야 하며, 공구는 단상 AC 전원에서만 작동할 수 있습니다. 이중 절연되었기 때문에 접지선 없는 소켓에 사용할 수 있습니다.



뜨거운 표면 - 손가락이나 손에 화상을 입을 수 있습니다.

설명

1. 슬라이드 스위치
2. 온도 설정 버튼 (2a -, 2b+)
3. 풍량 설정 버튼 (3a -, 3b+)
4. 확인 버튼
5. LCD
6. 사전 설정 버튼
7. 공기 흡입구
8. 전면 커버
9. 노즐

구성품 목록

- 기기, 전선, 전원 플러그 및 모든 부속품이 운송으로 인해 손상된 것이 없는지 확인하십시오.



경고: 포장 재료는 장난감이 아닙니다! 어린이가 포장 비닐을 가지고 놀지 않게 하십시오! 질식의 위험이 있습니다!

- 열풍기 1개
- 부속품 1 세트(부속품이 포함된 모델에만 해당)
- 사용 설명서 1개



누락되거나 손상된 부품이 있으면 대리점에 문의하십시오.

일반 안전 경고

이 전동공구와 함께 제공된 경고, 사용설명, 일러스트와 사양을 숙지하여 주십시오. 사용방법을 따르지 않으면 감전, 화재 및/또는 상해의 원인이 됩니다.

본 경고와 사용설명서를 잘 보관하여 주십시오.

아래의 모든 경고에서 '전동공구' 라고 하는 것은 전선으로 작동하는 전동공구와 배터리로 작동하는 충전식 전동공구를 의미합니다.

작업장의 안전

1. 작업장을 충분히 밝고 깨끗하게 유지하여 주십시오. 어질러지고 어두운 작업장은 사고의 원인이 됩니다.
2. 인화성 액체, 가스 또는 분진과 같이 폭발성 물질이 있는 환경에서 전동공구를 사용하지 마십시오. 전동공구에서 튀는 불꽃으로 분진이나 가스가 점화될 수 있습니다.
3. 전동공구가 작동되고 있을 때는 작업자 이외의 사람이나 어린이들의 접근을 막아 주십시오. 주위가 산만하면 제어력을 상실할 수 있습니다.

전기 안전

1. 전동공구의 플러그는 콘센트에 맞아야 합니다. 플러그를 절대로 개조하지 마십시오. 접지된 전동공구에 다른 플러그를 연결하여 사용하지 마십시오. 개조하지 않은 플러그와 규격의 콘센트는 감전의 위험을 줄여 줍니다.
2. 파이프, 난방기, 레인지, 냉장고와 같이 접지된 표면에 신체 접촉을 피하여 주십시오. 작업자의 몸이 닿을 경우 감전의 위험이 증가합니다.
3. 전동공구를 비나 습기에 노출시키지 마십시오. 물이 전동공구에 들어갈 경우 감전의 위험이 증가합니다.
4. 코드를 함부로 다루지 마십시오. 코드를 덩어 전동공구를 이동하거나 플러그를 뽑지 마십시오. 열, 오일, 날카로운 모서리, 회전부로부터 코드를 멀리하여 주십시오. 코드가 손상되거나 영키면 감전의 위험이 증가합니다.
5. 전동공구를 실외에서 사용할 경우에는 실외용 연결 코드를 사용하여 주십시오. 실외용 연결선은 감전의 위험을 줄여 줍니다.
6. 습도가 높은 곳에서 작업할 경우 누전차단기(RCD)를 사용하여 주십시오. RCD의 사용은 감전의 위험을 줄여 줍니다.
7. 잔류전류가 30mA 혹은 이보다 낮은 RCD가 내장된 전원공급장치를 사용할 것을 권장합니다.
8. 전동 공구는 사용자에게 해롭지 않은 전자장(EMF)을 생성할 수 있습니다. 하지만 심박 조율기 및 기타 비슷한 의료 장치의 사용자는 본 전동 공구를 사용하기 전에 해당 장치의 제조사 및/또는 의사에게 조언을 구해야 합니다.
9. 젖은 손으로 전원 플러그를 만지지 마십시오.
10. 코드가 손상된 경우에는 안전상의 위험을 피하기 위해 코드를 제조업체 또는 대리점에서 교체하십시오.

작업자 안전

1. 전동공구를 사용할 때는 방심하지 말고 어떤 작업을 하고 있는지 항상 주목하며 상식적으로 생각하며 작업하여 주십시오. 피곤하거나, 약을 복용하거나, 술을 마신 다음에는 전동공구를 사용하지 마십시오. 전동공구를 사용하는 동안 잠깐이라도 방심하면 심각한 상태 사고가 일어날 수 있습니다.
2. 안전 장비를 사용하여 주십시오. 항상 보안경을 착용하여 주십시오. 작업 환경에 적절하게 방진 마스크, 미끄럼방지 작업화, 작업모자, 귀마개와 같은 안전장비를 사용하면 상해를 줄일 수 있습니다.
3. 실수로 공구가 기동되지 않도록 하십시오. 공구를 이동하거나 들어올리거나 배터리나 전원을 연결하기 전에 스위치가 꺼져 있는지를 먼저 확인하여 주십시오. 전동공구의 스위치에 손가락을 넣은 상태로 이동하거나 스위치가 켜진 상태에서 플러그를 연결하면 사고가 날 수 있습니다.
4. 전동공구를 작동시키기 전에 먼저 조절기 또는 렌치를 제거하여 주십시오. 전동공구의 회전부에 렌치나 키가 꽂혀 있으면 상해의 원인이 됩니다.

5. 무리한 자세로 작업하지 마십시오. 항상 양발을 고정시켜 균형을 유지하여 주십시오. 예기치 않은 상황이 발생해도 전동공구를 잘 제어할 수 있습니다.
6. 적절한 복장으로 작업하여 주십시오. 헐렁한 옷이나 장신구를 착용하지 마십시오. 회전부에 머리카락, 의류가 끼지 않도록 주의하여 주십시오. 헐렁한 의류나, 장신구, 긴 머리카락은 회전부에 빨려 들어갈 수 있습니다.
7. 방진 및 집진 장비에 연결할 경우에는 제대로 연결하여 빠르게 사용하여 주십시오. 집진 장비를 사용하면 먼지로 발생하는 위험을 줄일 수 있습니다.
8. 젖은 공구 사용으로 익숙해졌다고 방심하거나 공구 안전 수칙을 무시하지 마십시오. 부주의한 행동은 순간간에 심각한 대인 상해를 야기할 수 있습니다.
9. 전기 공구 사용 시에 발생할 수 있는 부상을 방지하기 위해 항상 보호용 고글을 착용하십시오. 고글은 미국의 ANSI Z87.1, 유럽의 EN 166 또는 호주/뉴질랜드의 AS/NZS 1336을 준수한 것이어야 합니다. 호주/뉴질랜드에서는 얼굴 보호를 위해서 보호면(페이스 쉴드) 착용 또한 법적으로 규정되어 있습니다.

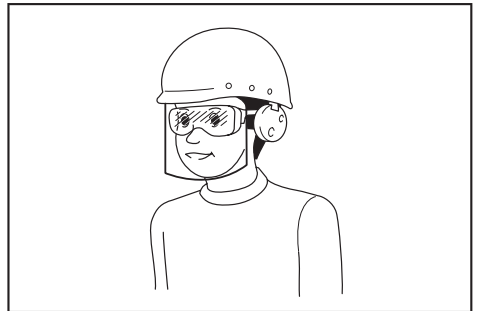

직원은 공구 사용자 및 작업장에 있는 다른 사람들이 적절한 안전 보호 장비를 사용하도록 해야 할 책임이 있습니다.

전동공구의 사용 및 관리

1. 전동공구를 무리하게 사용하지 마십시오. 용도에 맞는 전동공구를 사용하여 주십시오. 용도와 용량에 맞게 전동공구를 사용해야 능률적이고 안전하게 작업할 수 있습니다.
2. 스위치가 켜지거나 꺼지지 않으면 전동공구의 사용을 중단하여 주십시오. 스위치가 제대로 작동하지 않는 전동공구는 위험하므로 반드시 수리하여 주십시오.
3. 전동공구를 조정하거나, 부속품을 교환하거나, 보관하기 전에는 플러그를 뽑거나 부리가 가능하면 전동공구에서 배터리 팩을 제거해 주십시오. 이러한 안전조치는 전동공구가 예기치 않게 작동하는 위험을 줄여 줍니다.
4. 사용하지 않는 전동공구는 아이들의 손이 닿지 않는 곳에 보관하여 주시고, 전동공구나 본 설명서 내용에 익숙하지 않은 사람이 전동공구를 사용하지 않도록 하여 주십시오. 훈련받지 않은 작업자가 전동공구를 사용하는 것은 매우 위험합니다.
5. 동력 공구와 부속품을 유지 보수합니다. 회전부의 연결과 조정은 괜찮은지, 손상된 부분은 없는지 등 전동공구 작동에 영향을 줄 수 있는 모든 상태를 점검하여 주십시오. 공구가 손상되었으면 사용자 전에 반드시 수리를 받아 주십시오. 많은 사고가 전동공구의 유지보수를 제대로 하지 않아서 발생합니다.
6. 절삭용 공구는 날카롭고 깨끗하게 유지하여 주십시오.

오. 제대로 유지보수된 전동공구에 날카로운 절삭 날을 사용하면 작업 중에 날이 걸려 움직이지 않는 경우가 적으며 제어하기 쉬워집니다.

- 전동공구, 부속품, 공구 비트는 작업 조건과 작업 내용을 고려하여 선택하고, 이 설명서에 따라 사용하여 주십시오. 전동공구를 지정된 용도와 달리 사용하면 위험한 상황이 초래될 수 있습니다.
- 손잡이와 그립 표면은 항상 건조한 상태를 유지하고, 기름과 윤활유가 묻지 않도록 주의하여 주십시오. 미끄러운 손잡이와 그립 표면으로는 예기치 않은 상황에서 안전한 조작이나 제어를 할 수 없게 됩니다.
- 공구를 사용할 때는 얼릴 수 있는 천 소재 작업 장갑을 착용하지 마십시오. 천 소재 작업 장갑이 가동 부분에서 얼리면 부상을 입을 수 있습니다.

서비스

- 자격을 갖춘 전문가가 마끼다 순정부품을 사용하여 본 제품을 수리하도록 하여 주십시오. 그러면 전동 공구를 안전하게 사용하는 데 도움이 됩니다. 만일 전원 코드의 대치가 필요하면 이는 안전사고를 피하기 위해 제조자나 대리점에 의해 행해집니다.
- 주유 및 부속품의 교환 시에는 설명서의 지시를 따라 주십시오.

열풍기에 대한 추가적인 안전 지침



- 통풍구 위에 손을 올려놓거나 어떤 방식으로든 통풍구를 차단하지 마십시오.
- 이 공구의 노즐과 부속품은 사용하는 동안 매우 뜨거워집니다. 이러한 부분을 열이 식기 전에 만지지 마십시오.
- 항상 공구를 내려놓기 전에 스위치를 끄십시오.
- 공구를 스위치가 켜진 상태로 두고 자리를 비우지 마십시오.
- 기기를 주의해서 사용하지 않으면 화재가 발생할 수 있습니다.
- 보이지 않는 곳에 있는 가연성 물질에 열이 전도될 수 있습니다. 습기가 있는 환경, 인화성 가스가 있거나 가연성 물질 가까이에서 사용하지 마십시오.







- 공구가 완전히 식은 후에 보관하십시오.
- 유독 가스가 발생할 수 있으므로 적절한 환기를 유지하십시오.
- 헤어드라이어로 사용하지 마십시오.
- 공기 흡입구 또는 노즐 출구를 막지 마십시오. 열이 축적되어 공구가 손상될 수 있습니다.
- 열기가 다른 사람을 향하지 하지 마십시오.
- 금속 노즐은 사용하는 동안 매우 뜨거워지므로 만지지 마십시오. 사용 후에도 30분 정도 뜨거움이 유지됩니다.
- 사용하는 동안 또는 사용 직후 노즐을 어디에도 기대어 놓지 마십시오.
- 무엇으로도 노즐을 찌르지 마십시오. 감전될 수 있습니다. 기기 작동 중에는 높은 열이 발생하므로 노즐을 들여다보지 마십시오.
- 노즐이나 스크래퍼에 페인트가 들러붙지 않게 하십시오. 나중에 불이 붙을 수 있습니다.

페인트 제거

- 이 공구를 납을 함유한 페인트 제거에 사용하지 마십시오. 페인트의 벗겨진 부분, 잔류물 및 기화 물질에 유독한 납이 포함되어 있을 수 있습니다. 1960년 이전의 건물은 과거에 납이 함유된 페인트로 도색한 후 그 위에 페인트를 덧칠했을 수 있습니다. 표면에 침적되면 손이 입에 닿는 것으로 납을 섭취할 수 있습니다. 낮은 수치라도 납에 노출되면 돌이킬 수 없는 뇌 손상 또는 신경계 손상을 초래할 수 있습니다. 유아와 태아는 특히 이 위험에 취약합니다.
- 페인트를 제거할 때에는 작업 구역을 격리하십시오. 되도록이면 방진 마스크를 착용하십시오.
- 페인트를 태우지 마십시오. 스크래퍼를 사용하고 노즐을 페인트 표면과 최소 25 mm 이상 거리를 유지하십시오. 수직 방향으로 작업할 때에는 페인트가 공구에 떨어져 불이 붙는 것을 방지하기 위해 아래쪽으로 작업하십시오.
- 모든 페인트 잔해를 안전하게 폐기하고 작업을 완료한 후에는 작업 구역을 철저히 청소하십시오.

올바른 부속품 설치(해당되는 경우)

아이콘	설명	용도
	유리 보호 노즐	틀을 벗겨낼 때 창문 보호
	반사 노즐	파이프 용접
	축소 노즐	용접, 슬리브 수축(작은 면적에 열 집중)

아이콘	설명	용도
	와이드 슬롯 노즐	건조, 해동(넓은 면적에 열 확산)
	오버랩 용접 노즐	용접
	납땜 슬리브 반사기	납땜
	용접 노즐	용접
	가압 롤러	작업물의 표면 누르기
	스크래퍼	페인트 및 니스 제거



- 공구의 스위치를 끄고 노즐이 식었는지 확인하십시오.
- 노즐을 떨어뜨리면 바닥에 있는 물체에 불이 붙을 수 있습니다. 노즐을 기기에 단단히 설치하고 고정해야 합니다.
- 뜨거운 노즐을 만지면 심각한 화상을 입을 수 있습니다. 노즐을 설치하거나 교체하기 전에 기기를 완전히 식히거나 적절한 연장을 사용하십시오.
- 뜨거운 노즐이 닿은 표면에 불이 붙을 수 있습니다. 노즐을 내화 표면에만 내려 놓으십시오.
- 올바르게 사용하지 않거나 결함이 있는 노즐은 열이 축적되어 기기를 손상시킬 수 있습니다. 표를 참조하여 기기에 적합한 원래 노즐만 사용하십시오.

사용 지침



적절한 설정을 모르겠으면 낮은 온도부터 설정하여 최적 결과가 달성될 때까지 점차 온도를 올리십시오.



항상 안전 지침과 해당 규정을 준수하십시오.



한 손으로만 공구를 잡으십시오. 다른 한 손을 통풍구 위에 올려놓지 마십시오. (그림 1)



공구 하우징의 구멍을 높은 위치에서 떨어뜨리지 않기 위한 용도로 사용하지 마십시오.

사용하기 전에

- 용도에 맞는 부속품을 설치하십시오.

스위치 켜기 및 끄기

- 스위치의 숫자는 다음을 의미합니다.

HG6530V:

- 0: OFF 위치
- 1: 약 50°C 송풍으로 식히기
- 2: 낮은 풍량으로 가열
- 3: 높은 풍량으로 가열

HG6531C:

- 0: OFF 위치
- 1: 약 50°C 송풍으로 식히기
- 2: 가열

- 열풍기를 켜려면 슬라이드 스위치(1)를 0에서 ON 위치 1, 2 또는 3으로 밀어서 켜십시오.
- 열풍기를 끄려면 슬라이드 스위치를 1 위치로 밀어서 잠시 열을 식힌 후에 0 위치(OFF)로 밀어서 끄십시오.



열풍기를 켜면 잠깐 동안 연기가 날 수 있습니다. 이것은 기기에 문제가 있는 것이 아닙니다.

온도 설정하기(HG6530V)

슬라이드 스위치(1)를 2 또는 3 위치로 설정하여 온도를 설정할 수 있습니다.

- 온도 설정 버튼 + (2b)를 눌러 온도를 높이고, - (2a)를 눌러 온도를 낮추십시오. 온도를 설정하면 몇 초 후 LCD(5)에 송풍 온도가 표시됩니다.
- 온도 단위를 °C 또는 °F로 변경하려면 + 버튼과 - 버튼을 동시에 누르십시오.

사전 설정 모드 선택하기(HG6531C)

14개의 사전 설정 모드를 사용하여 주요 용도에 적합한 온도와 풍량을 빠르게 설정할 수 있습니다. 다음 절차에 따라 원하는 사전 설정 용도를 선택하십시오.

1. 슬라이드 스위치(1)를 2 위치로 설정합니다. LCD(5)에 마지막에 사용한 용도명과 해당 온도 및 풍량 설정이 표시됩니다. 몇 초 후 LCD에 송풍 사전 설정 온도가 표시됩니다.
2. 사전 설정 버튼(6)을 누릅니다. 용도명을 스크롤합니다.
3. 온도 설정 버튼(2a/b) 또는 풍량 설정 버튼(3a/b)을 눌러 용도를 선택합니다. 원하는 용도명이 LCD에 표시되면 확인 버튼(4)을 눌러 선택합니다.



5-6초 안에 확인 버튼(4)을 눌러 설정을 확인하지 않으면 기기는 이전에 확인된 설정으로 돌아갑니다.

온도 및 풍량 설정하기(HG6531C)

다음 절차에 따라 온도 및 풍량을 변경하십시오. 슬라이드 스위치(1)를 1 위치로 설정하면 풍량만 변경할 수 있습니다.



슬라이드 스위치를 2 위치로 설정하면 현재 LCD에 표시된 용도의 사전 설정된 온도와 풍량을 변경할 수 있습니다.

1. 슬라이드 스위치(1)를 1 또는 2 위치로 설정합니다.
2. 온도 설정 버튼(2a/b)을 눌러 온도를 변경합니다. 풍량 설정 버튼(3a/b)을 눌러 풍량을 변경합니다. LCD(5)의 온도 및 풍량 표시가 깜박입니다.
3. 확인 버튼(4)을 눌러 설정을 확인합니다. LCD의 온도 및 풍량 표시가 깜박임을 멈춥니다. 몇 초 후 LCD에 송풍 사전 설정 온도가 표시됩니다.



5-6초 안에 확인 버튼(4)을 눌러 설정을 확인하지 않으면 기기는 이전에 확인된 설정으로 돌아갑니다.

표시 언어 및 온도 단위 설정하기(HG6531C)

1. 슬라이드 스위치(1)를 1/2 위치로 설정합니다.
2. 언어 메뉴가 깜박일 때까지 사전 설정 버튼(6)을 누릅니다.
3. 온도 단위를 °C 또는 °F로 변경하려면 온도 설정 버튼(2a/b)을 누릅니다. 언어를 변경하려면 풍량 설정 버튼(3a/b)을 누릅니다. 10가지 언어 중에서 선택할 수 있습니다: 영어, 독일어, 이탈리아어, 프랑스어, 스페인어, 포르투갈어, 네덜란드어, 스웨덴어, 중국어, 일본어.
4. 확인 버튼(4)을 눌러 설정을 확인합니다.

탈착식 전면 커버

- 좁은 곳에 작업을 해야 할 경우 전면 커버를 제거할 수 있습니다.



뜨거운 노즐을 주의하십시오. 전면 커버를 제거하면 뜨거운 노즐이 노출되어 화상의 위험이 증가합니다.

페인트 제거

- 적절한 부속품을 설치하십시오.
- 높은 온도를 설정하십시오.
- 공구의 스위치를 켜십시오.
- 제거하려는 페인트에 열기가 향하게 하십시오.
- 페인트가 부드러워지면 스크래퍼를 사용하여 페인트를 벗겨내십시오.



급속 창틀의 경우 열이 유리에 전도되어 이미 갈 수 있으므로 급속 창틀에는 사용하지 마십시오. 다른 창틀을 벗겨낼 때에는 유리 보호 노즐을 사용하십시오.



표면에 불이 붙는 것을 방지하기 위해 공구가 너무 오랫동안 한 위치를 향하게 하지 마십시오.



불이 붙을 수 있으므로 스크래퍼에 페인트가 쌓이지 않게 하십시오. 필요한 경우 나이프를 사용하여 스크래퍼에 쌓인 페인트 잔해를 주의해서 제거하십시오.

고정 사용

이 공구를 고정 모드로 사용할 수도 있습니다.

- 공구를 안정적인 작업대 위에 올려놓으십시오.
- 공구가 작업대에서 벗어나지 않도록 케이블을 고정시키십시오.
- 주의해서 공구를 켜십시오.



노즐이 사용자와 주변에 있는 사람을 향하지 않게 항상 주의하십시오.



노즐에 아무 것도 떨어뜨리지 마십시오.

냉각

노즐과 부속품은 사용하는 동안 매우 뜨거워집니다. 공구가 완전히 식은 후에 옮기거나 보관하십시오.

- 냉각 시간을 줄이려면 공구 스위치를 가장 낮은 온도로 켜고 몇 분 동안 작동하십시오.
- 공구의 스위치를 끄고 최소 30분 이상 식히십시오. 항상 수직으로 세워 두십시오.

열풍기 내부가 뜨거워지면 LCD의 표시가 깜박입니다.



이 경우, 슬라이드 스위치를 1 위치로 설정하여 열풍기를 식히십시오. 열풍기가 완전히 식은 후에 다시 사용하십시오.

다시 사용한 후에도 LCD가 깜박이면 가까운 Makita 서비스 센터에 문의하십시오.

유지관리 및 청소



주의: 공구에 작업을 수행하기 전에 전원 플러그를 뽑으십시오.

유지관리

- 이 전동공구는 최소의 유지관리로 장기간 사용할 수 있도록 설계되었습니다. 공구를 적절하게 관리하고 정기적으로 청소하면 만족스러운 작동 성능을 계속 유지할 수 있습니다.

윤활

- 이 전동공구는 추가적인 윤활이 필요하지 않습니다.

청소

- 모터가 과열되는 것을 방지하기 위해 기기의 통풍구를 깨끗하게 유지하고 먼지와 이물질이 쌓이지 않게 하십시오.
- 정기적으로, 가능하면 매번 사용한 후, 부드러운 천을 사용하여 공구의 하우징을 청소하십시오. 먼지가 떨어지지 않으면 비눗물을 적신 부드러운 천을 사용하십시오.



가솔린, 알코올, 암모니아수 등과 같은 용제를 절대 사용하지 마십시오. 이러한 용제는 플라스틱 부분을 손상시킬 수 있습니다.

기술 데이터

모델 번호:	HG6531C	HG6530V
전압	220V~60Hz	220V~60Hz
전력	2000W	2000W
온도 송풍량	I 50°C 200-550L/M II 50-650°C 200-550L/M	I 50°C 500L/M II 50-650°C 280L/M III 50-650°C 550L/M
전체 길이	257mm	257mm
순 중량	0.71kg	0.72kg

사전 설정 모드의 기본 설정

번호	온도명	온도	풍량
1	자유 설정 1	250°C	5
2	자유 설정 2	500°C	5
3	수축	300°C	3
4	성형	250°C	4
5	구리 납땜	650°C	3
6	페인트 건조	650°C	5
7	페인트 제거	450°C	5
8	플로어 포일 용접	450°C	3
9	PPEPDM 용접	280°C	3
10	HDPE 용접	300°C	3
11	PP 용접	320°C	3
12	PVC-U 용접	340°C	3
13	ABS 용접	360°C	3
14	PC 용접	380°C	3

환경



이 기기를 일정 기간 사용 후 교체해야 할 경우, 가정용 쓰레기로 폐기해서는 안 되며 환경적으로 안전하게 폐기해야 합니다.

전기 기기에서 발생한 폐기물을 일반 가정용 쓰레기로 취급해서는 안 됩니다. 재활용 센터로 보내 주십시오. 지역의 관할 기관이나 제품을 구매한 대리점에 재활용에 대한 정보를 문의하십시오.

예고 없이 변경될 수 있습니다.

⚠ PERINGATAN

Peralatan ini tidak dapat digunakan oleh anak-anak atau orang dengan kemampuan fisik, sensorik atau mental yang rendah, atau kurangnya pengalaman dan pengetahuan. Anak-anak tidak boleh bermain dengan peralatan ini. Pembersihan dan perawatan pengguna tidak boleh dilakukan oleh anak-anak.

Jika kabel suplai rusak, kabel harus diganti oleh produsen, agen servisnya atau staf dengan kualifikasi serupa untuk menghindari bahaya.

Kebakaran bisa terjadi jika peralatan tidak digunakan dengan hati-hati, oleh karena itu:

- hati-hati saat menggunakan peralatan ini di tempat yang mudah terbakar;
- jangan gunakan pada tempat yang sama untuk waktu yang lama;
- jangan gunakan jika ada atmosfer yang mudah meledak;
- waspadalah bahwa panas dapat diteruskan ke bahan mudah terbakar yang tidak terawasi;
- letakkan peralatan pada tempatnya setelah digunakan dan biarkan dingin sebelum disimpan;
- jangan tinggalkan peralatan tanpa pengawasan saat dinyalakan.

MAKSUD PENGGUNAAN

Heat gun Anda dirancang untuk melunturkan cat, menyolder pipa, menyusutkan PVC, mengelas, dan membengkokkan plastik, serta pengeringan dan pencairan secara umum.



PERINGATAN: Bacalah petunjuk manual dan petunjuk keselamatan umum ini secara seksama sebelum menggunakan alat ini, demi keselamatan diri Anda sendiri. Alat daya Anda hanya boleh diberikan kepada orang lain bersama dengan petunjuk ini.



Alat ini harus dihubungkan hanya dengan satu daya dari voltase yang sama seperti yang ditunjukkan pada papan nama, dan hanya dapat dioperasikan pada suplai AC satu fase. Alat ini berlapis ganda dan dapat juga digunakan dari soket tanpa kawat tanah.



Permukaan panas - Luka bakar pada jari atau tangan.

DESKRIPSI

1. Sakelar geser
2. Tombol pengatur suhu (2a -, 2b+)
3. Tombol pengaturan volume udara (3a -, 3b +)
4. Tombol konfirmasi
5. LCD
6. Tombol prasetel
7. Saluran udara
8. Tutup depan
9. Nosel

DAFTAR ISI KEMASAN

- Periksa peralatan, kabel daya, steker listrik, dan semua aksesoris apakah ada kerusakan saat transportasi.



PERINGATAN: Bahan kemasan bukan mainan! Anak-anak tidak boleh bermain dengan kantong plastik! Bahaya tersedak!

- 1 Heat gun
- 1 Rangkaian aksesoris (Aksesoris mungkin tidak disertakan)
- 1 Pedoman petunjuk



Jika ada bagian yang hilang atau rusak, hubungi pengecer Anda.

PERINGATAN KESELAMATAN UMUM MESIN LISTRIK

Bacalah semua peringatan keselamatan, petunjuk, ilustrasi dan spesifikasi yang disertakan bersama mesin listrik ini. Kelalaian untuk mematuhi semua petunjuk yang tercantum di bawah ini dapat menyebabkan sengatan listrik, kebakaran dan/atau cedera serius.

Simpanlah semua peringatan dan petunjuk untuk acuan di masa depan.

Istilah "mesin listrik" dalam semua peringatan mengacu pada mesin listrik yang dijalankan dengan sumber listrik jala-jala (berkabel) atau baterai (tanpa kabel).

Keselamatan tempat kerja

1. **Jaga tempat kerja selalu bersih dan berpenerangan cukup.** Tempat kerja yang berantakan dan gelap mengundang kecelakaan.
2. **Jangan gunakan mesin listrik dalam lingkungan yang mudah meledak, misalnya jika ada cairan, gas, atau debu yang mudah menyala.** Mesin listrik menimbulkan bunga api yang dapat menyalaikan debu atau uap tersebut.
3. **Jauhkan anak-anak dan orang lain saat menggunakan mesin listrik.** Bila perhatian terpecah, anda dapat kehilangan kendali.

Keamanan Kelistrikan

1. **Steker mesin listrik harus cocok dengan stopkontak.** Jangan sekali-kali mengubah steker dengan cara apa pun. **Jangan menggunakan steker adaptor dengan mesin listrik terbumi (dibumikan).** Steker yang tidak diubah dan stopkontak yang cocok akan mengurangi risiko sengatan listrik.
2. **Hindari sentuhan tubuh dengan permukaan terbumi atau yang dibumikan seperti pipa, radiator, kompor, dan kulkas.** Risiko sengatan listrik bertambah jika tubuh Anda terbumikan atau dibumikan.
3. **Jangan membiarkan mesin listrik kehujanan atau kebasahan.** Air yang masuk ke dalam mesin listrik akan meningkatkan risiko sengatan listrik.
4. **Jangan menyalahgunakan kabel.** **Jangan sekali-kali menggunakan kabel untuk membawa, menarik, atau mencabut mesin listrik dari stopkontak.** Jauhkan kabel dari panas, minyak, tepian tajam, atau bagian yang bergerak. Kabel yang rusak atau kusut memperbesar risiko sengatan listrik.
5. **Bila menggunakan mesin listrik di luar ruangan, gunakan kabel ekstensi yang sesuai untuk penggunaan di luar ruangan.** Penggunaan kabel yang sesuai untuk penggunaan luar ruangan mengurangi risiko sengatan listrik.
6. **Jika mengoperasikan mesin listrik di lokasi lembap tidak terhindarkan, gunakan pasokan**

daya yang dilindungi peranti imbasan arus (residual current device - RCD). Penggunaan RCD mengurangi risiko sengatan listrik.

7. **Penggunaan pasokan daya melalui RCD dengan kapasitas arus sisa 30 mA atau kurang selalu dianjurkan.**
8. **Mesin listrik dapat menghasilkan medan magnet (EMF) yang tidak berbahaya bagi pengguna.** Namun, pengguna alat pacu jantung atau peralatan medis sejenisnya harus berkonsultasi dengan produsen peralatan tersebut dan/atau dokter mereka sebelum mengoperasikan mesin listrik ini.
9. **Jangan menyentuh colokan daya dengan tangan basah.**
10. **Jika kabel rusak, penggantian harus dilakukan oleh produsen atau agennya untuk menghindari bahaya keselamatan.**

Keselamatan Diri

1. **Jaga kewaspadaan, perhatikan pekerjaan Anda dan gunakan akal sehat bila menggunakan mesin listrik.** **Jangan menggunakan mesin listrik saat Anda lelah atau di bawah pengaruh obat bius, alkohol, atau obat.** Sekejap saja lalai saat menggunakan mesin listrik dapat menyebabkan cedera badan serius.
2. **Gunakan alat pelindung diri. Selalu gunakan pelindung mata.** Peralatan pelindung seperti masker debu, sepatu pengaman anti-selip, helm pengaman, atau pelindung telinga yang digunakan untuk kondisi yang sesuai akan mengurangi risiko cedera badan.
3. **Cegah penyalaaan yang tidak disengaja.** **Pastikan bahwa sakelar berada dalam posisi mati (off) sebelum menghubungkan mesin ke sumber daya dan/atau paket baterai, atau mengangkat atau membawanya.** Membawa mesin listrik dengan jari Anda pada sakelarnya atau mengalirkan listrik pada mesin listrik yang sakelarnya hidup (on) akan mengundang kecelakaan.
4. **Lepaskan kunci-kunci penyetel sebelum menghidupkan mesin listrik.** Kunci-kunci yang masih terpasang pada bagian mesin listrik yang berputar dapat menyebabkan cedera.
5. **Jangan meraih terlalu jauh. Jagalah pijakan dan keseimbangan sepanjang waktu.** Hal ini memungkinkan kendali yang lebih baik atas mesin listrik dalam situasi yang tidak diharapkan.
6. **Kenakan pakaian yang memadai. Jangan memakai pakaian yang longgar atau perhiasan.** Jaga jarak antara rambut dan pakaian Anda dengan komponen mesin yang bergerak. Pakaian yang longgar, perhiasan, atau rambut yang panjang dapat tersangkut pada komponen yang bergerak.
7. **Jika tersedia fasilitas untuk menghisap dan mengumpulkan debu, pastikan fasilitas tersebut terhubung listrik dan digunakan dengan baik.** Penggunaan pembersih debu dapat mengurangi bahaya yang terkait dengan debu.
8. **Jangan sampai Anda lengah dan mengabaikan prinsip keselamatan mesin ini hanya karena sudah sering mengoperasikannya dan sudah merasa terbiasa.** Tindakan yang lalai dapat

menyebabkan cedera berat dalam sepersekian detik saja.

9. **Selalu kenakan kacamata pelindung untuk melindungi mata dari cedera saat menggunakan mesin listrik. Kacamata harus sesuai dengan ANSI Z87.1 di Amerika Serikat, EN 166 di Eropa, atau AS/NZS 1336 di Australia/Selandia Baru. Di Australia/Selandia Baru, secara hukum Anda juga diwajibkan mengenakan pelindung wajah untuk melindungi wajah Anda.**

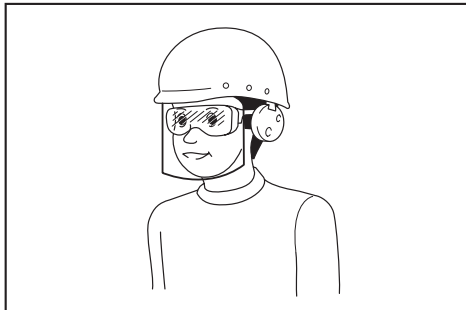

Menjadi tanggung jawab atasan untuk menerapkan penggunaan alat pelindung keselamatan yang tepat bagi operator mesin dan orang lain yang berada di area kerja saat itu.

Penggunaan dan pemeliharaan mesin listrik

1. **Jangan memaksa mesin listrik. Gunakan mesin listrik yang tepat untuk keperluan Anda.** Mesin listrik yang tepat akan menuntaskan pekerjaan dengan lebih baik dan aman pada kecepatan sesuai rancangannya.
2. **Jangan gunakan mesin listrik jika sakelar tidak dapat menyala dan mematakannya.** Mesin listrik yang tidak dapat dikendalikan dengan sakelarnya adalah berbahaya dan harus diperbaiki.
3. **Cabut steker dari sumber listrik dan/atau lepas paket baterai, jika dapat dilepas, dari mesin listrik sebelum melakukan penyetulan apa pun, mengganti aksesoris, atau menyimpan mesin listrik.** Langkah keselamatan preventif tersebut mengurangi risiko hidupnya mesin secara tak sengaja.
4. **Simpan mesin listrik jauh dari jangkauan anak-anak dan jangan biarkan orang yang tidak paham mengenai mesin listrik tersebut atau petunjuk ini menggunakan mesin listrik.** Mesin listrik sangat berbahaya di tangan pengguna yang tak terlatih.
5. **Rawatlah mesin listrik dan aksesoris. Periksa apakah ada komponen bergerak yang tidak lurus atau macet, komponen yang pecah, dan kondisi-kondisi lain yang dapat memengaruhi pengoperasian mesin listrik. Jika rusak, perbaiki dahulu mesin listrik sebelum digunakan.** Banyak kecelakaan disebabkan oleh kurangnya pemeliharaan mesin listrik.
6. **Jaga agar mesin pemotong tetap tajam dan bersih.** Mesin pemotong yang terawat baik dengan mata pemotong yang tajam tidak mudah macet dan lebih mudah dikendalikan.

7. **Gunakan mesin listrik, aksesoris, dan mata mesin, dll. sesuai dengan petunjuk ini, dengan memperhitungkan kondisi kerja dan jenis pekerjaan yang dilakukan.** Penggunaan mesin listrik untuk penggunaan yang lain dari peruntukan dapat menimbulkan situasi berbahaya.
8. **Jagalah agar gagang dan permukaan pegangan tetap kering, bersih, dan bebas dari minyak dan pelumas.** Gagang dan permukaan pegangan yang licin tidak mendukung keamanan penanganan dan pengendalian mesin dalam situasi-situasi tak terduga.
9. **Ketika menggunakan mesin, jangan menggunakan sarung tangan kain yang dapat tersangkut.** Sarung tangan kain yang tersangkut pada komponen bergerak dapat mengakibatkan cedera pada pengguna.

Servis

1. **Berikan mesin listrik untuk diperbaiki hanya kepada oleh teknisi yang berkualifikasi dengan menggunakan hanya suku cadang pengganti yang serupa.** Hal ini akan menjamin terjaganya keamanan mesin listrik.
2. **Patuhi petunjuk pelumasan dan penggantian aksesoris.**

INSTRUKSI KESELAMATAN TAMBAHAN UNTUK HEAT GUN

- **Jangan meletakkan tangan di atas ventilasi atau menghalangi ventilasi dengan cara apa pun.**
- **Nosel dan aksesoris alat ini menjadi sangat panas saat digunakan. Biarkan bagian ini dingin sebelum menyentuhnya.**
- **Selalu matikan alat sebelum meletakkannya.**
- **Jangan tinggalkan alat tanpa pengawasan saat dinyalakan.**
- **Kebakaran bisa timbul jika peralatan tidak digunakan dengan hati-hati.**
- **Panas dapat diteruskan ke bahan mudah terbakar yang tidak terawasi. Jangan gunakan di atmosfer yang lembap, di mana gas yang mudah terbakar mungkin ada atau mendekati bahan yang mudah terbakar.**
- **Biarkan alat sepenuhnya dingin sebelum menyimpannya.**
- **Pastikan ventilasi udara memadai karena asap beracun mungkin dihasilkan.**
- **Jangan gunakan sebagai pengering rambut.**
- **Jangan menghalangi masukan udara atau soket nosel, karena dapat menyebabkan penumpukan panas berlebih sehingga merusak alat.**
- **Jangan arahkan tekanan udara panas kepada orang lain.**
- **Jangan menyentuh logam nosel karena nosel menjadi sangat panas saat digunakan dan akan tetap panas hingga 30 menit setelah penggunaan.**
- **Jangan letakkan nosel di atas apa pun saat menggunakan atau segera setelah penggunaan.**
- **Jangan menyodokkan apa pun ke nosel karena**

dapat menyebabkan Anda tersengat listrik. Jangan melihat bagian bawah nosel saat unit bekerja karena suhu tinggi sedang dihasilkan.

- Jangan biarkan cat menempel pada nosel atau pengikis karena bisa terbakar setelah beberapa saat.







Menghapus cat



- Jangan gunakan alat ini untuk menghilangkan cat yang mengandung timbal. Kelupasan, residu, dan uap cat bisa mengandung timbal yang beracun. Setiap bangunan sebelum tahun 1960 mungkin dicat dengan cat yang mengandung timbal dan ditutupi lapisan cat tambahan. Setelah timbal terkumpul di permukaan, menyentuh tangan yang tercemar ke mulut bisa mengakibatkan timah tertelan.

Paparan bahkan pada tingkat timbal yang rendah dapat menyebabkan kerusakan yang tidak dapat diperbaiki pada otak dan sistem saraf. Anak kecil dan janin sangat rentan terhadap hal ini.

- Saat menghapus cat, pastikan tempat kerja tertutup. Sebaiknya gunakan masker debu.
- Jangan membakar catnya. Gunakan pengikis dan jaga jarak nosel setidaknya 25 mm dari permukaan yang dicat. Saat bekerja dengan arah vertikal, bekerjalah dengan arah turun untuk mencegah agar cat tidak jatuh ke alat dan terbakar.
- Buang semua puing cat dengan aman dan pastikan area kerja dibersihkan dengan benar setelah pekerjaan selesai.

MEMASANG AKSESORI YANG BENAR (JIKA MEMUNGKINKAN)

Ikona	Deskripsi	Tujuan
	Nosel perlindungan kaca	Jendela perlindungan ketika melepas bingkai
	Nosel reflektor	Menyolder pipa
	Nosel reduksi	Mengelas, menyusutkan selongsong (panas terkonsentrasi di atas area kecil)
	Nosel slot lebar	Mengeringkan, mencairkan (panas tersebar di atas area yang lebih luas)
	Nosel pengelas overlap	Pengelasan
	Reflektor selongsong solder	Penyolderan

Ikon	Deskripsi	Tujuan
	Nosel penyolderan	Pengelasan
	Roller tekanan	Tekan permukaan benda kerja
	Pengkikis	Mengikis cat dan pernis



- Pastikan alat dimatikan dan nosel sudah dingin.
- Nosel yang jatuh mungkin menyulut benda-benda di lantai. Nosel harus dipasang dengan kuat dan aman pada unit.
- Menyentuh nosel panas dapat menyebabkan luka bakar yang serius. Sebelum memasang atau mengganti nosel, biarkan unit benar-benar dingin atau gunakan alat yang sesuai.
- Nosel panas bisa membakar permukaan. Tempatkan nosel panas hanya pada permukaan yang tahan api.
- Nosel yang salah atau cacat dapat menyebabkan akumulasi panas dan kerusakan unit. Gunakan hanya nosel yang asli sesuai dengan tabel yang sesuai untuk unit Anda.

PETUNJUK PENGGUNAAN



Jika Anda tidak yakin dengan pengaturan yang benar, mulailah dengan pengaturan suhu rendah dan tingkatkan suhu secara bertahap sampai Anda mencapai hasil yang optimal.



Selalu amati petunjuk keselamatan dan peraturan yang berlaku.



Gunakan hanya satu tangan untuk memegang alat ini, jangan letakkan tangan Anda yang lain di atas ventilasi udara. (Gambar 1)



Jangan gunakan lubang pada rumah alat untuk tujuan agar tidak terjatuh di lokasi yang tinggi.

Sebelum pengoperasian

- Pasang aksesoris yang benar untuk digunakan.

Menghidupkan dan mematikan

- Nomor sakelar geser memiliki arti sebagai berikut.
 - HG6530V:
 - 0: Posisi MATI
 - 1: Untuk mendinginkan dengan aliran udara sekitar 50°C

2: Untuk pemanasan dengan volume udara rendah

3: Untuk pemanasan dengan volume udara tinggi

HG6531C:

0: Posisi MATI

1: Untuk mendinginkan dengan aliran udara sekitar 50°C

2: Untuk pemanasan

- Untuk menghidupkan heat gun, geser sakelar geser (1) dari 0 ke salah satu dari posisi HIDUP 1, 2 atau 3.
- Untuk mematikan heat gun, atur sakelar geser ke posisi 1 untuk mendinginkan sementara waktu, dan kemudian atur sakelar geser ke posisi 0 (MATI).



Heat gun dapat mengeluarkan asap segera setelah dimatikan. Ini tidak mengindikasikan adanya masalah dengan alat.

Mengatur suhu (HG6530V)

Suhu dapat diatur dengan sakelar geser (1) di posisi 2 atau 3.

- Tekans tombol pengaturan suhu + (2b) untuk meningkatkan suhu, dan - (2a) untuk menurunkan suhu. LCD (5) menampilkan suhu aliran udara saat ini beberapa detik setelah suhu target diatur.
- Untuk berpindah unit suhu antara °C atau °F, tekan + dan - bersama-sama.

Memilih mode prasetel (HG6531C)

14 mode prasetel tersedia untuk mengatur suhu dengan cepat dan volume udara sesuai dengan aplikasi utama. Pilih aplikasi prasetel yang diinginkan seperti berikut.

1. Atur sakelar geser (1) di posisi 2. LCD (5) menampilkan nama aplikasi yang digunakan pada saat terakhir, serta suhu terkait dan pengaturan volume udara. Beberapa detik berikutnya, LCD menampilkan suhu aliran udara terkini.
2. Tekan tombol prasetel (6). Nama aplikasi akan mulai ditelusuri.
3. Tekan tombol pengaturan suhu (2a/b) atau tombol pengaturan volume udara (3a/b) untuk memilih aplikasi. Jika nama aplikasi yang diinginkan ditampilkan pada LCD, tekan tombol konfirmasi (4) untuk memutuskannya.



Setiap saat pengaturan tidak dikonfirmasi dengan menekan tombol konfirmasi (4) dalam 5-6 detik, alat akan kembali ke pengaturan yang dikonfirmasi sebelumnya.

Mengatur suhu dan volume udara (HG6531C)

Mengatur suhu dan volume udara seperti berikut. Dengan sakelar geser (1) di posisi 1, hanya volume udara yang dapat diubah.



Dengan sakelar geser di posisi 2, prosedur ini akan menimpa suhu prasetel dan volume udara dari aplikasi yang saat ini ditampilkan pada LCD.

1. Atur sakelar geser (1) di posisi 1 atau 2.
2. Tekan tombol pengaturan suhu (2a/b) untuk mengubah suhu. Tekan tombol pengaturan volume udara (3a/b) untuk mengubah volume udara. Indikator suhu dan volume udara pada LCD (5) mulai berkedip.
3. Tekan tombol konfirmasi (4) untuk mengonfirmasi pengaturan. Suhu dan volume udara pada LCD mulai berkedip. Beberapa detik berikutnya, LCD menampilkan suhu aliran udara terkini.



Setiap saat pengaturan tidak dikonfirmasi dengan menekan tombol konfirmasi (4) dalam 5-6 detik, alat akan kembali ke pengaturan yang dikonfirmasi sebelumnya.

Mengatur bahasa display dan satuan suhu (HG6531C)

1. Atur sakelar geser (1) ke posisi 1/2.
2. Tekan dan tahan tombol prasetel (6) hingga bilah bahasa berkedip.
3. Untuk berpindah satuan suhu antara °C atau °F, tekan tombol pengaturan suhu (2a/b). Untuk mengubah bahasa, tekan tombol pengaturan volume udara (3a/b). Tersedia 10 bahasa: Bahasa Inggris, bahasa Jerman, bahasa Italia, bahasa Prancis, bahasa Spanyol, Portugis, Belanda, Swedia, Cina, dan Jepang.
4. Tekan tombol konfirmasi (4) untuk menentukan pengaturan.

Tutup depan yang bisa dilepas

- Penutup depan bisa dilepas saat bekerja di area yang sempit.



Hati-hati dengan nosel yang panas. Melepaskan penutup depan meningkatkan risiko luka bakar dengan nosel panas tanpa penutup.

Mengikis cat

- Pasang aksesoris yang sesuai.
- Atur suhu udara tinggi.
- Hidupkan alat ini.
- Arahkan udara panas ke cat yang akan dihapus.
- Saat cat meleleh, kikis cat menggunakan pengikis tangan.



Jangan melepas rangka jendela logam, karena panas dapat diteruskan ke kaca dan memecahkannya. Saat melepas rangka jendela lainnya, gunakan nosel perlindungan kaca.



Jangan arahkan pada satu tempat terlalu lama untuk mencegah permukaan menyala.



Hindari mengumpulkan cat pada aksesoris pengikis, karena bisa terbakar. Jika perlu, dengan hati-hati lepaskan serpihan cat dari aksesoris pengikis menggunakan pisau.

Penggunaan stasioner

Alat ini juga bisa digunakan dalam mode stasioner.

- Letakkan alat di atas meja kerja yang stabil.
- Amankan kabel agar tidak menarik alat dari meja kerja.
- Hidupkan alat ini dengan hati-hati.



Pastikan nosel selalu mengarah berlawanan dari Anda dan orang lain.



Pastikan agar tidak memasukkan apa pun ke dalam nosel.

Mendinginkan

Nosel dan aksesoris menjadi sangat panas saat digunakan. Biarkan mendingin sebelum mencoba memindahkan atau menyimpan alat ini.

- Untuk mengurangi waktu pendinginan, matikan alat pada pengaturan suhu udara terendah dan biarkan selama beberapa menit.
- Matikan alat dan biarkan dingin setidaknya selama 30 menit. Selalu letakkan secara vertikal dan berdiri.



Ketika bagian dalam heat gun menjadi terlalu panas, indikasi pada LCD berkedip.

Jika terjadi demikian, atur sakelar geser ke posisi 1 untuk mendinginkan alat. Setelah benar-benar dingin, mulai ulang pengoperasian.

Jika LCD masih berkedip setelah alat dinyalakan ulang, hubungi Pusat Servis Makita setempat.

PERAWATAN DAN PEMBERSIHAN



Perhatian: Sebelum melakukan pekerjaan apa pun pada peralatan, cabut steker listrik.

Perawatan

- Mesin Listrik Anda dirancang untuk beroperasi dalam jangka waktu yang lama dengan perawatan minimal. Operasi memuaskan yang berkelanjutan bergantung pada perawatan alat yang tepat dan pembersihan secara rutin.

Pelumasan

- Mesin listrik Anda tidak memerlukan pelumasan tambahan.

Pembersihan

- Untuk mencegah pemanasan motor, jaga slot ventilasi mesin tetap bersih dan bebas dari debu dan kotoran.
- Bersihkan mesin secara teratur dengan kain lembut, sebaiknya setelah setiap penggunaan. Jika debu bandel, gunakan kain lembut yang dibasahi dengan air sabun.



Jangan pernah menggunakan pelarut seperti bensin, alkohol, air amonia, dan lain-lain. Pelarut ini dapat merusak komponen plastik.

DATA TEKNIS

Model No:	HG6531C	HG6530V
Voltase	220-240V-50Hz	220-240V-50Hz
Daya	2000W	2000W
Suhu	I 50°C 200-550L/M	I 50°C 500L/M
Aliran udara	II 50-650°C 200-550L/M	II 50-650°C 280L/M III 50-650°C 550L/M
Panjang keseluruhan	257mm	257mm
Berat sama	0,71kg	0,72kg

Pengaturan standar untuk mode prasetel

Nomor	Nama aplikasi	Suhu	Volume udara
1	ATURAN BEBAS 1	250°C	5
2	ATURAN BEBAS 2	500°C	5
3	PENYUSUTAN	300°C	3
4	PEMBENTUKAN	250°C	4
5	MENYOLDER TEMBAGA	650°C	3
6	MENGERINGKAN CAT	650°C	5
7	PEMBERSIHAN CAT	450°C	5
8	MENGELAS FOIL LANTAI	450°C	3
9	MENGELAS PPEPDM	280°C	3
10	MENGELAS HDPE	300°C	3
11	MENGELAS PP	320°C	3
12	MENGELAS PVC-U	340°C	3
13	MENGELAS ABS	360°C	3
14	MENGELAS PC	380°C	3

LINGKUNGAN HIDUP



Jika peralatan Anda harus diganti setelah lama digunakan, jangan membuangnya bersama sampah rumah tangga melainkan buang dengan cara yang ramah lingkungan.

Limbah yang dihasilkan oleh item mesin listrik tidak boleh ditangani seperti sampah rumah tangga biasa. Daur ulang di mana fasilitas disediakan. Tanyakan kepada Pemerintah atau pengecer setempat untuk mendapatkan saran tentang daur ulang.

Perubahan dapat dilakukan tanpa pemberitahuan.

CẢNH BÁO

Trẻ em hoặc người bị giảm năng lực thể chất, cảm giác hoặc tâm thần hoặc thiếu kinh nghiệm và kiến thức không được sử dụng thiết bị này. Trẻ em không được chơi với thiết bị này. Trẻ em không được thực hiện việc vệ sinh và bảo trì cho người dùng.

Nếu dây nguồn bị hỏng, nó phải được nhà sản xuất, đại lý bảo dưỡng hoặc những người có trình độ tương đương thay thế để tránh gây nguy hiểm.

Có thể xảy ra hỏa hoạn nếu thiết bị không được sử dụng cẩn thận, do đó:

- hãy cẩn thận khi sử dụng thiết bị ở những nơi có vật liệu dễ cháy;
- không sử dụng cho cùng một chỗ trong thời gian dài;
- không sử dụng trong môi trường khí dễ nổ;
- lưu ý rằng có thể dẫn nhiệt sang các vật liệu dễ cháy nằm ngoài tầm nhìn;
- đặt thiết bị lên giá đỡ sau khi sử dụng và để nguội trước khi cất giữ;
- không để thiết bị không được giám sát khi đã bật nguồn điện.

CÔNG DỤNG THEO THIẾT KẾ

Máy khò này được thiết kế để loại bỏ sơn, hàn ống, làm co ống PVC, hàn và uốn cong nhựa, cũng như dùng cho các mục đích sấy và rã đông chung.



CẢNH BÁO: Hãy đọc kỹ tài liệu hướng dẫn này và các hướng dẫn an toàn chung trước khi sử dụng thiết bị để đảm bảo an toàn cho chính bạn. Chỉ giao thiết bị điện của bạn cho người khác sử dụng khi có kèm những hướng dẫn này.



Chỉ kết nối thiết bị này với nguồn điện có cùng điện áp như được nêu trên bảng tên, và chỉ vận hành ở nguồn điện AC một pha. Chúng được cách điện kép và do đó có thể sử dụng từ các ổ điện mà không cần có dây tiếp địa.



Bề mặt nóng - Bông ngón tay hoặc bàn tay.

4. Nút xác nhận
5. LCD
6. Nút đặt sẵn
7. Đường dẫn khí
8. Nắp trước
9. Vòi

PHIẾU ĐÓNG GÓI

- Kiểm tra thiết bị, dây nguồn, phích cắm và tất cả phụ kiện đi kèm xem có bị hư hại trong quá trình vận chuyển không.



CẢNH BÁO: Vật liệu đóng gói không phải là đồ chơi! Trẻ em không được chơi với túi nhựa! Nguy cơ ngạt thở!

- 1 Máy khò
- 1 Bộ phụ kiện (Phụ kiện không nhất thiết phải được giao kèm theo)
- 1 Tài liệu hướng dẫn sử dụng



Trường hợp thiếu hoặc hư hại phụ tùng, vui lòng liên hệ với đại lý của bạn.

MÔ TẢ

1. Công tắc trượt
2. Nút cài đặt nhiệt độ (2a -, 2b+)
3. Nút cài đặt thể tích không khí (3a -, 3b+)

CẢNH BÁO AN TOÀN CHUNG DÀNH CHO DỤNG CỤ MÁY

Xin đọc tất cả các cảnh báo an toàn, hướng dẫn, minh họa và thông số kỹ thuật đi kèm với dụng cụ máy này. Việc không tuân theo các hướng dẫn được liệt kê dưới đây có thể dẫn đến điện giật, hỏa hoạn và/hoặc thương tích nghiêm trọng.

Lưu giữ tất cả cảnh báo và hướng dẫn để tham khảo sau này.

Thuật ngữ “dụng cụ máy” trong các cảnh báo đề cập đến dụng cụ máy (có dây) được vận hành bằng nguồn điện chính hoặc dụng cụ máy (không dây) được vận hành bằng pin của bạn.

An toàn tại nơi làm việc

- Giữ nơi làm việc sạch sẽ và có đủ ánh sáng.** Nơi làm việc bừa bộn hoặc tối thường dễ gây ra tai nạn.
- Không vận hành dụng cụ máy trong môi trường cháy nổ, ví dụ như môi trường có sự hiện diện của các chất lỏng, khí hoặc bụi dễ cháy.** Các dụng cụ máy tạo tia lửa điện có thể làm bụi hoặc khí bốc cháy.
- Giữ trẻ em và người ngoài tránh xa nơi làm việc khi đang vận hành dụng cụ máy.** Sự xao lãng có thể khiến bạn mất khả năng kiểm soát.

An toàn về Điện

- Phích cắm của dụng cụ máy phải khớp với ổ cắm. Không được sửa đổi phích cắm theo bất kỳ cách nào. Không sử dụng bất kỳ phích cắm chuyển đổi nào với các dụng cụ máy được nối đất (tiếp đất).** Các phích cắm còn nguyên vẹn và ổ cắm phù hợp sẽ giảm nguy cơ điện giật.
- Tránh tiếp xúc với các bề mặt nóng đất hoặc tiếp đất như đường ống, bộ tản nhiệt, bếp ga và tủ lạnh.** Nguy cơ bị điện giật sẽ tăng lên nếu cơ thể bạn được nối đất hoặc tiếp đất.
- Không để dụng cụ máy tiếp xúc với mưa hoặc trong điều kiện ẩm ướt.** Nước lọt vào dụng cụ máy sẽ làm tăng nguy cơ điện giật.
- Không làm dụng cụ máy dây điện. Không được phép sử dụng dây để mang, kéo hoặc tháo phích cắm dụng cụ máy. Giữ dây tránh xa nguồn nhiệt, dầu, các mép sắc hoặc các bộ phận chuyển động.** Dây bị hỏng hoặc bị rối sẽ làm tăng nguy cơ điện giật.
- Khi vận hành dụng cụ máy ngoài trời, hãy sử dụng dây kéo dài phù hợp cho việc sử dụng ngoài trời.** Việc dùng dây phù hợp cho việc sử dụng ngoài trời sẽ giảm nguy cơ điện giật.
- Nếu bắt buộc phải vận hành dụng cụ máy ở nơi ẩm ướt, hãy sử dụng nguồn cấp điện được bảo vệ bằng thiết bị ngắt dòng điện rò (RCD).** Việc sử dụng RCD sẽ làm giảm nguy cơ điện giật.
- Chúng tôi luôn khuyến bạn sử dụng nguồn cấp điện qua thiết bị RCD có thể ngắt dòng điện rò định mức 30 mA hoặc thấp hơn.**
- Các dụng cụ máy có thể tạo ra từ trường điện (EMF) có hại cho người dùng.** Tuy nhiên, người dùng máy trợ tim và những thiết bị y tế tương tự khác nên liên hệ với nhà sản xuất thiết bị và/hoặc

bác sỹ để được tư vấn trước khi vận hành dụng cụ này.

- Không chạm vào đầu cắm điện bằng tay ướt.**
- Nếu dây bị hỏng, hãy nhờ nhà sản xuất hoặc đại lý thay dây mới để tránh nguy hiểm về an toàn.**

An toàn Cá nhân

- Luôn tinh táo, quan sát những việc bạn đang làm và sử dụng những phán đoán theo kinh nghiệm khi vận hành dụng cụ máy. Không sử dụng dụng cụ máy khi bạn đang mệt mỏi hoặc chịu ảnh hưởng của ma túy, rượu hay thuốc.** Chỉ một khoảnh khắc không tập trung khi đang vận hành dụng cụ máy cũng có thể dẫn đến thương tích cá nhân nghiêm trọng.
- Sử dụng thiết bị bảo hộ cá nhân. Luôn đeo thiết bị bảo vệ mắt.** Các thiết bị bảo hộ như mặt nạ chống bụi, giày an toàn chống trượt, mũ bảo hộ hay thiết bị bảo vệ thính giác được sử dụng trong các điều kiện thích hợp sẽ giúp giảm thương tích cá nhân.
- Tránh vô tình khởi động dụng cụ máy. Đảm bảo công tắc ở vị trí off (tắt) trước khi nối nguồn điện và/hoặc bộ pin, cầm hoặc di chuyển dụng cụ máy.** Việc di chuyển dụng cụ máy khi đang đặt ngón tay ở vị trí công tắc hoặc cấp điện cho dụng cụ máy đang bật thường dễ gây ra tai nạn.
- Tháo tất cả các khóa hoặc cờ lê điều chỉnh trước khi bật dụng cụ máy.** Việc cờ lê hoặc khóa vẫn còn gắn vào bộ phận quay của dụng cụ máy có thể dẫn đến thương tích cá nhân.
- Không vội quá cao. Luôn giữ thăng bằng tốt và có chỗ để chân phù hợp.** Điều này cho phép điều khiển dụng cụ máy tốt hơn trong những tình huống bất ngờ.
- Ăn mặc phù hợp. Không mặc quần áo rộng hay đeo đồ trang sức. Giữ tóc và quần áo tránh xa các bộ phận chuyển động.** Quần áo rộng, đồ trang sức hay tóc dài có thể mắc vào các bộ phận chuyển động.
- Nếu các thiết bị được cung cấp để kết nối các thiết bị thu gom và hút bụi, hãy đảm bảo chúng được kết nối và sử dụng hợp lý.** Việc sử dụng thiết bị thu gom bụi có thể làm giảm những mối nguy hiểm liên quan đến bụi.
- Không vì quen thuộc do thường xuyên sử dụng các dụng cụ mà cho phép bạn trở nên tự mãn và bỏ qua các nguyên tắc an toàn dụng cụ.** Một hành động bất cẩn có thể gây ra thương tích nghiêm trọng trong một phần của một giây.
- Luôn luôn mang kính bảo hộ để bảo vệ mắt khỏi bị thương khi đang sử dụng các dụng cụ máy. Kính bảo hộ phải tuân thủ ANSI Z87.1 ở Mỹ, EN 166 ở Châu Âu, hoặc AS/NZS 1336 ở Úc/New Zealand. Tại Úc/New Zealand, theo luật pháp, bạn cũng phải mang mặt nạ che mặt để bảo vệ mắt.**

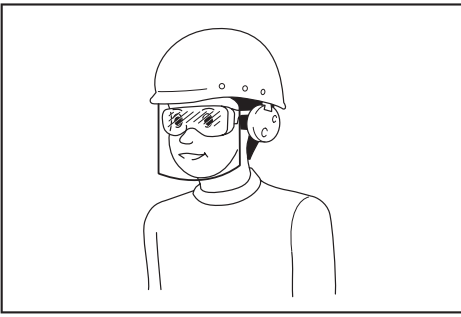

Trách nhiệm của chủ lao động là bắt buộc người vận hành dụng cụ và những người khác trong khu vực làm việc cạnh đó phải sử dụng các thiết bị bảo hộ an toàn thích hợp.

Sử dụng và bảo quản dụng cụ máy

1. Không dùng lực đối với dụng cụ máy. Sử dụng đúng dụng cụ máy cho công việc của bạn. Sử dụng đúng dụng cụ máy sẽ giúp thực hiện công việc tốt hơn và an toàn hơn theo giá trị định mức được thiết kế của dụng cụ máy đó.
2. Không sử dụng dụng cụ máy nếu công tắc không bật và tắt được dụng cụ máy đó. Mọi dụng cụ máy không thể điều khiển được bằng công tắc đều rất nguy hiểm và phải được sửa chữa.
3. Rút phích cắm ra khỏi nguồn điện và/hoặc tháo kết nối bộ pin khỏi dụng cụ máy, nếu có thể tháo rời trước khi thực hiện bất kỳ công việc điều chỉnh, thay đổi phụ tùng hay cất giữ dụng cụ máy nào. Những biện pháp an toàn phòng ngừa này sẽ giảm nguy cơ vô tình khởi động dụng cụ máy.
4. Cất giữ các dụng cụ máy không sử dụng ngoài tầm với của trẻ em và không cho bất kỳ người nào không có hiểu biết về dụng cụ máy hoặc các hướng dẫn này vận hành dụng cụ máy. Dụng cụ máy sẽ rất nguy hiểm nếu được sử dụng bởi những người dùng chưa qua đào tạo.
5. Bảo dưỡng dụng cụ máy và các phụ kiện. Kiểm tra tình trạng lệch trục hoặc bó kẹt của các bộ phận chuyển động, hiện tượng nứt vỡ của các bộ phận và mọi tình trạng khác mà có thể ảnh hưởng đến hoạt động của dụng cụ máy. Nếu có hỏng hóc, hãy sửa chữa dụng cụ máy trước khi sử dụng. Nhiều tai nạn xảy ra là do không bảo quản tốt dụng cụ máy.
6. Luôn giữ cho dụng cụ cất được sắc bén và sạch sẽ. Những dụng cụ cất được bảo quản tốt có mép cắt sắc sẽ ít bị kẹt hơn và dễ điều khiển hơn.
7. Sử dụng dụng cụ máy, phụ tùng và đầu dụng cụ cắt, v.v... theo các hướng dẫn này, có tính đến điều kiện làm việc và công việc được thực hiện. Việc sử dụng dụng cụ máy cho các công việc khác với công việc dự định có thể gây nguy hiểm.
8. Giữ tay cầm và bề mặt tay cầm khô, sạch, không dính dầu và mỡ. Tay cầm trơn trượt và bề mặt tay cầm không cho phép xử lý an toàn và kiểm soát dụng cụ trong các tình huống bất ngờ.
9. Khi sử dụng dụng cụ, không được đi giày tay

lao động bằng vải, có thể bị vướng. Việc gắng tay lao động bằng vải vướng vào các bộ phận chuyển động có thể gây ra thương tích cá nhân.

Bảo dưỡng

1. Để nhân viên sửa chữa đủ trình độ bảo dưỡng dụng cụ máy của bạn và chỉ sử dụng các bộ phận thay thế đồng nhất. Việc này sẽ đảm bảo duy trì được độ an toàn của dụng cụ máy.
2. Tuân theo hướng dẫn dành cho việc bôi trơn và thay phụ tùng.

HƯỚNG DẪN AN TOÀN BỔ SUNG CHO MÁY KHÒ

- Không đặt tay bạn ở lỗ thông hơi hoặc chặn các lỗ thông hơi bằng bất cứ cách nào.
- Vòi phun và phụ kiện của thiết bị này trở nên cực kỳ nóng trong quá trình sử dụng. Hãy để những bộ phận này nguội trước khi chạm vào.
- Luôn tắt thiết bị trước khi đặt nó xuống.
- Không để thiết bị không được giám sát trong khi đã bật nguồn điện.
- Có thể xảy ra hỏa hoạn nếu thiết bị không được sử dụng cẩn thận.
- Nhiệt có thể dẫn sang các vật liệu dễ cháy nằm ngoài tầm nhìn. Không sử dụng thiết bị trong môi trường khí ẩm ướt, nơi có thể có các khí dễ cháy hoặc gần các vật liệu dễ cháy.
- Để thiết bị nguội hoàn toàn trước khi cất giữ.
- Đảm bảo thông gió đầy đủ vì có thể sản sinh ra khói độc hại.
- Không sử dụng thiết bị làm máy sấy tóc.
- Không chắn cửa hút khí hoặc cửa xả vòi phun khí, vì điều này có thể gây ra quá nhiệt gây hư hại cho thiết bị.
- Không hướng luồng khí nóng về phía người khác.
- Không chạm vào vòi phun kim loại vì nó trở nên rất nóng trong quá trình sử dụng và vẫn còn nóng lên đến 30 phút sau khi sử dụng.
- Không đặt vòi phun vào bất cứ thứ gì trong khi hoặc ngay sau khi sử dụng.
- Không chọc bất cứ thứ gì vào vòi phun vì nó có thể gây điện giật cho bạn. Không nhìn vào vòi phun trong khi thiết bị đang làm việc do nhiệt độ cao đang phát ra.
- Không để sơn dính vào vòi phun hoặc mũi nạo vì nó có thể bốc cháy sau một khoảng thời gian.

Loại bỏ sơn









- Không sử dụng thiết bị này để loại bỏ sơn có chứa chì. Các vỏ bọc, chất cặn và hơi của sơn có thể chứa chì có thể gây ngộ độc. Bất kỳ tòa nhà nào trước năm 1960 có thể đã được sơn trong quá khứ bằng sơn chứa chì và phủ thêm lớp sơn phụ.
Khi đã tích tụ trên bề mặt, tay chạm miệng cũng có thể dẫn đến việc nuốt phải chì. Tiếp xúc với chì dù chỉ là một lượng thấp cũng có thể gây ra tổn thương không thể phục hồi cho não và hệ thần kinh. Trẻ nhỏ và trẻ chưa sinh đặc biệt dễ bị tổn thương.
- Khi loại bỏ sơn, đảm bảo rằng nơi làm việc đã

được bao kín. Tốt hơn là đeo mặt nạ chống bụi.

- Không được đốt sơn. Sử dụng mũi nạo và giữ cho vòi phun cách bề mặt sơn ít nhất 25 mm. Khi làm việc theo chiều dọc, hãy làm việc theo hướng từ trên xuống dưới để tránh sơn rơi vào thiết bị và gây cháy.

- Vứt bỏ tất cả các mảnh vụn sơn một cách an toàn và đảm bảo nơi làm việc được vệ sinh sạch sẽ sau khi hoàn thành công việc.

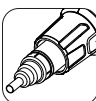
LẮP ĐÚNG PHỤ KIỆN (NẾU ÁP DỤNG)

Biểu tượng	Mô tả	Mục đích
	Vòi phun bảo vệ kính	Bảo vệ cửa sổ khi loại bỏ khung
	Vòi phun dẫn ngược hơi	Hàn các đường ống
	Vòi phun thu nhỏ	Hàn, làm co ngót ống (nhiệt tập trung vào một phạm vi nhỏ)
	Vòi phun miệng rộng	Sấy, rà đồng (nhiệt trải đều trên phạm vi rộng)
	Mỏ hàn chông chéo	Hàn
	Bộ đẩy ngược ống hàn	Mối hàn
	Vòi hàn	Hàn
	Trục lăn áp lực	Nhấn bề mặt cửa chi tiết gia công

Biểu tượng	Mô tả	Mục đích
	Mũi nọ	Loại bỏ sơn và véc-ni.



- Đảm bảo đã tắt thiết bị và vòi phun đã nguội.
- Vòi phun rơi xuống có thể làm cháy các vật trên sàn nhà. Vòi phun phải được gắn chắc chắn và an toàn trên thiết bị.
- Chạm vào vòi phun nóng có thể bị bỏng nghiêm trọng. Trước khi gắn hoặc thay vòi phun, hãy để cho thiết bị nguội hoàn toàn hoặc sử dụng một dụng cụ phù hợp.
- Một vòi nóng có thể khiến một bề mặt cháy. Chỉ được đặt vòi phun nóng trên các bề mặt chống cháy.
- Sử dụng vòi phun không đúng hoặc bị hỏng có thể dẫn đến sự tích tụ nhiệt và làm hỏng thiết bị. Chỉ sử dụng vòi phun gốc theo bảng thích hợp cho thiết bị của bạn.

HƯỚNG DẪN SỬ DỤNG



Nếu bạn chưa chắc chắn nhiệt độ phù hợp, hãy bắt đầu với cài đặt nhiệt độ thấp và tăng dần nhiệt độ cho đến khi bạn đạt được kết quả tối ưu.



Luôn tuân thủ các hướng dẫn an toàn và các quy định áp dụng.



Chỉ sử dụng một tay để giữ thiết bị, không đặt tay kia lên lỗ thông khí. (Hình 1)



Không sử dụng các lỗ trên vỏ thiết bị cho mục đích để phòng rơi xuống ở vị trí cao.

Trước khi vận hành thiết bị

- Gắn phụ kiện phù hợp với từng mục đích sử dụng.

- Bật và tắt**
- Số lượng công tắc trượt có nghĩa là như sau.
HG6530V:
0: Vị trí TẮT
1: Để làm mát với luồng khí khoảng 50°C
2: Để làm nóng với thể tích không khí thấp
3: Để làm nóng với thể tích không khí cao
HG6531C:
0: Vị trí TẮT
1: Để làm mát với luồng khí khoảng 50°C
2: Để làm nóng
 - Để bật máy khô, trượt công tắc trượt (1) từ 0 đến một trong các vị trí BẬT 1, 2 hoặc 3.
 - Để tắt máy khô, đặt công tắc trượt về vị trí 1 để làm mát một lúc, sau đó đặt công tắc trượt về vị trí 0 (TẮT).



Máy khô có thể phát ra khói ngay sau khi bật. Đây không phải dấu hiệu sự cố với thiết bị.

- Đặt nhiệt độ (HG6530V)**
- Có thể đặt nhiệt độ bằng công tắc trượt (1) ở vị trí 2 hoặc 3.
- Nhấn nút cài đặt nhiệt độ + (2b) để tăng nhiệt độ, và - (2a) để giảm nhiệt độ. LCD (5) hiển thị nhiệt độ hiện tại của luồng khí vài giây sau khi nhiệt độ đích được đặt.
 - Để chuyển đổi đơn vị nhiệt độ giữa °C hoặc °F, nhấn + và - cùng lúc.

- Chọn chế độ đặt sẵn (HG6531C)**
- Có 14 chế độ đặt sẵn để nhanh chóng đặt nhiệt độ và thể tích không khí phù hợp cho các ứng dụng chính. Chọn ứng dụng đặt sẵn mong muốn như sau.
1. Đặt công tắc trượt (1) ở vị trí 2. LCD (5) hiển thị tên ứng dụng được sử dụng ở lần cuối cùng và các cài đặt nhiệt độ và thể tích không khí tương ứng. Vài giây sau, LCD hiển thị nhiệt độ hiện tại của luồng khí.
 2. Nhấn nút đặt sẵn (6). Tên ứng dụng bắt đầu cuộn.
 3. Nhấn các nút cài đặt nhiệt độ (2a/b) hoặc nút cài đặt thể tích không khí (3a/b) để chọn ứng dụng. Khi tên ứng dụng mong muốn được hiển thị trên LCD, nhấn nút xác nhận (4) để quyết định.



Bất cứ khi nào cài đặt không được xác nhận bằng cách nhấn nút xác nhận (4) trong vòng 5-6 giây, thiết bị sẽ trở về cài đặt đã xác nhận trước đó.

Đặt nhiệt độ và thể tích không khí (HG6531C)

Thay đổi nhiệt độ và thể tích không khí như sau. Với công tắc trượt (1) ở vị trí 1, chỉ có thể thay đổi thể tích không khí.



Với công tắc trượt ở vị trí 2, quy trình này sẽ bỏ qua nhiệt độ và thể tích không khí đặt sẵn của ứng dụng hiện đang được hiển thị trên LCD.

1. Đặt công tắc trượt (1) ở vị trí 1 hoặc 2.
2. Nhấn các nút cài đặt nhiệt độ (2a/b) để thay đổi nhiệt độ. Nhấn các nút cài đặt thể tích không khí (3a/b) để thay đổi thể tích không khí. Các chỉ báo về nhiệt độ và thể tích không khí trên màn hình

LCD (5) bắt đầu nhấp nháy.

3. Nhấn nút xác nhận (4) để xác nhận cài đặt. Nhiệt độ và thể tích không khí trên LCD dừng nhấp nháy. Vài giây sau, LCD hiển thị nhiệt độ hiện tại của luồng khí.



Bất cứ khi nào cài đặt không được xác nhận bằng cách nhấn nút xác nhận (4) trong vòng 5-6 giây, thiết bị sẽ trở về cài đặt đã xác nhận trước đó.

Cài đặt ngôn ngữ hiển thị và đơn vị nhiệt độ (HG6531C)

1. Đặt công tắc trượt (1) đến vị trí 1/2.
2. Nhấn giữ nút đặt sẵn (6) cho đến khi thanh ngôn ngữ nhấp nháy.
3. Để chuyển đổi đơn vị nhiệt độ giữa °C hoặc °F, nhấn các nút cài đặt nhiệt độ (2a//b). Để thay đổi ngôn ngữ, nhấn các nút cài đặt thể tích không khí (3a//b). Có sẵn 10 ngôn ngữ: Anh, Đức, Ý, Pháp, Tây Ban Nha, Bồ Đào Nha, Hà Lan, Thụy Điển, Trung Quốc và Nhật Bản.
4. Nhấn nút xác nhận (4) để quyết định cài đặt của bạn.

Nắp trước tháo rời được

- Nắp trước có thể tháo ra khi thao tác trong một khu vực hẹp.



Cẩn thận với vòi phun nóng.
Việc tháo nắp trước làm tăng nguy cơ bị bỏng do vòi phun nóng.

Loại bỏ sơn

- Gắn phụ kiện phù hợp.
- Cài đặt nhiệt độ khí cao.
- Bật thiết bị.
- Hướng khí nóng lên bề mặt sơn cần loại bỏ.
- Khi sơn mềm, cạo sạch sơn bằng mũi nạo cầm tay.



Không tháo các khung cửa sổ kim loại, vì nhiệt có thể được dẫn lên kính và làm nó bị nứt vỡ. Khi tháo các khung cửa sổ khác, hãy sử dụng vòi phun bảo vệ kính.



Không hướng thiết bị vào một điểm quá lâu để tránh gây cháy bề mặt.



Tránh thu gom sơn trên mũi nạo, vì nó có thể bốc cháy. Nếu cần thiết, hãy cẩn thận loại bỏ các mảnh vụn sơn khỏi mũi nạo bằng dao.

Sử dụng tĩnh

Thiết bị này cũng có thể được sử dụng ở chế độ tĩnh.

- Đặt thiết bị lên một bàn làm việc vững chắc.
- Cố định dây cáp để tránh việc kéo thiết bị ra khỏi bàn làm việc.
- Cẩn thận bật thiết bị.



Đảm bảo rằng vòi phun luôn hướng ra xa khỏi bạn và những người xung quanh



Đảm bảo không thả bất cứ thứ gì vào vòi phun.

Làm nguội

Vòi phun và phụ kiện trở nên cực kỳ nóng trong quá trình sử dụng. Để chúng nguội hẳn trước khi di chuyển hoặc cất giữ thiết bị.

- Để giảm thời gian làm nguội, hãy bật thiết bị ở mức nhiệt thấp nhất và để cho nó chạy trong vài phút.
- Tắt thiết bị và để nguội trong ít nhất 30 phút. Luôn đặt nó thẳng và đứng.



Khi phần bên trong súng bắn sơn trở nên quá nóng, chỉ báo trên LCD nhấp nháy.

Trong trường hợp đó, hãy đặt công tắc trượt đến vị trí 1 để làm nguội dụng cụ. Sau khi nguội hoàn toàn, bắt đầu lại hoạt động.

Nếu LCD vẫn nhấp nháy sau khi khởi động lại, hãy liên hệ Trung tâm Dịch vụ Makita tại địa phương của bạn.

BẢO TRÌ VÀ VỆ SINH



Chú ý: Trước khi thực hiện bất kỳ công việc nào trên thiết bị, hãy kéo khóa phích cắm.

Bảo trì

- Thiết bị điện này được thiết kế để hoạt động trong một khoảng thời gian dài với mức bảo trì tối thiểu. Việc thiết bị hoạt động đạt yêu cầu liên tục hay không phụ thuộc vào việc bảo quản cẩn thận và vệ sinh thường xuyên.

Tra dầu mỡ

- Thiết bị điện này không yêu cầu thêm dầu bôi trơn.

Vệ sinh

- Để tránh làm động cơ quá nóng, giữ cho các khe thông gió của máy sạch sẽ và không dính bụi bẩn.
- Thường xuyên lau chùi vỏ máy bằng vải mềm, tốt nhất là ngay sau mỗi lần sử dụng. Nếu bụi bẩn không bong ra thì dùng một miếng vải mềm làm ẩm bằng nước xà phòng.



Không bao giờ được sử dụng các dung môi như xăng, cồn, nước amoniac, v.v. Những dung môi này có thể làm hỏng các bộ phận bằng nhựa.

DỮ LIỆU KỸ THUẬT

Số mẫu máy:	HG6531C	HG6530V
Điện áp	220-240V~50Hz	220-240V~50Hz
Công suất	2000W	2000W
Nhiệt độ	I 50°C 200-550L/M	I 50°C 500L/M
Luồng khí	II 50-650°C 200-550L/M	II 50-650°C 280L/M
		III 50-650°C 550L/M
Tổng chiều dài	257mm	257mm
Trọng lượng tịnh	0,71kg	0,72kg

Cài đặt mặc định của chế độ đặt sẵn

STT	Tên ứng dụng	Nhiệt độ	Thể tích không khí
1	ĐẶT TỰ DO 1	250°C	5
2	ĐẶT TỰ DO 2	500°C	5
3	ĐỘ CO	300°C	3
4	ĐỊNH HÌNH	250°C	4
5	ĐỒNG HÀN	650°C	3
6	LÀM KHÔ SƠN	650°C	5
7	TẤY SƠN	450°C	5
8	TẤM NỀN HÀN	450°C	3
9	HÀN PPEPDM	280°C	3
10	HÀN HDPE	300°C	3
11	HÀN PP	320°C	3
12	HÀN PVC-U	340°C	3
13	HÀN ABS	360°C	3
14	HÀN PC	380°C	3

MÔI TRƯỜNG



Nếu cần phải thay thế thiết bị của bạn sau thời gian sử dụng kéo dài thì không được vứt bỏ nó cùng rác thải sinh hoạt mà phải xử lý nó theo cách an toàn với môi trường.

Không xử lý chất thải phát sinh từ máy móc điện tử như rác thải sinh hoạt thông thường. Vui lòng tái chế tại những nơi có cơ sở vật chất phù hợp. Hãy liên hệ với Cơ quan chức năng tại địa phương hoặc đại lý của bạn để được tư vấn về tái chế.

Có thể thay đổi mà không cần thông báo trước.

คำแนะนำเพิ่มเติม

คำเตือน

เครื่องมือนี้ไม่สามารถใช้งานได้โดยเด็กหรือบุคคลผู้มีสภาพร่างกาย ประสาทสัมผัส หรือสภาพจิตใจ ที่บกพร่อง หรือขาดความรู้และประสบการณ์ในการใช้งาน ไม่ควรให้เด็กเล็กเล่นกับเครื่องมือนี้ ไม่ควรให้เด็กเล็กทำความสะอาดหรือบำรุงรักษาเครื่องมือ

หากสายไฟชำรุด ต้องทำการเปลี่ยนโดยผู้ผลิต ตัวแทนผู้ให้บริการหรือบุคคลที่ได้รับการรับรองในระดับเดียวกันเพื่อหลีกเลี่ยงการเกิดอันตราย

อาจทำให้เกิดไฟไหม้ได้หากไม่ใช้เครื่องมืออย่างระมัดระวัง เพราะฉะนั้น:

- ควรจะระมัดระวังเมื่อใช้เครื่องมือในสถานที่ที่มีวัสดุติดไฟได้ง่าย
- อย่าใช้ในสถานที่เดียวกันเป็นเวลานาน
- อย่าใช้ในสถานที่ที่สภาพแวดล้อมอาจเกิดการระเบิดได้
- ควรตระหนักว่าความร้อนอาจสัมผัสกับวัสดุที่ติดไฟได้ง่ายที่มองไม่เห็น
- วางเครื่องมือบนขาตั้งหลังเลิกใช้งาน และวางให้เย็นลงก่อนทำการจัดเก็บ
- อย่าวางเครื่องมือทิ้งไว้โดยไม่ดูแลเมื่อเปิดเครื่องไว้

วัตถุประสงค์การใช้งาน

ปืนเป่าลมร้อนของคุณได้รับการออกแบบมาเพื่อวัตถุประสงค์สำหรับการลอกสี บัดกรีท่อ ทำให้พีวีซีหดตัว การเชื่อมและการตัดพลาสติก รวมทั้งการอบแห้งและการละลายน้ำแข็งโดยทั่วไป



คำเตือน: อ่านคู่มือฉบับนี้และคำแนะนำทั่วไปด้านความปลอดภัยอย่างละเอียดก่อนที่จะใช้เครื่องมือเพื่อความปลอดภัยของคุณเอง ควรส่งมอบเครื่องมือไฟฟ้าของคุณพร้อมกับคู่มือเหล่านี้เท่านั้น



เครื่องมือนี้ควรจะเชื่อมต่อกับแหล่งจ่ายไฟที่มีแรงดันไฟฟ้าเท่ากับที่ระบุไว้ในแผ่นป้ายเท่านั้น และสามารถใช้งานได้เฉพาะกับแหล่งจ่ายไฟกระแสสลับแบบเฟสเดียวเท่านั้น โดยมีฉนวนหุ้มสองชั้น จึงสามารถใช้งานได้ทันทีโดยไม่ต้องสวมใส่ถุงมือ



ผิวสัมผัสมีความร้อน ทำให้นิ้วหรือมือไหม้ได้

คำอธิบาย

1. สวิตช์แบบเลื่อน
2. ปุ่มตั้งค่าอุณหภูมิ (2a -, 2b+)

3. ปุ่มตั้งค่าปริมาตรอากาศ (3a -, 3b+)
4. ปุ่มยืนยัน
5. หน้าจอ LCD
6. ปุ่มตั้งค่าล่วงหน้า
7. ช่องอากาศเข้า
8. ฝาครอบด้านหน้า
9. หัวฉีด

รายการสิ่งที่อยู่ในบรรจุภัณฑ์

- ตรวจสอบเครื่องมือ สายไฟ ปลั๊กไฟและอุปกรณ์เสริมทั้งหมดที่อาจเสียหายจากการขนส่ง



คำเตือน: วัสดุบรรจุภัณฑ์ไม่ใช่ของเล่น! ห้ามเด็กเล่นกับถุงพลาสติก! อันตรายจากการหายใจไม่ออก!

- ปืนเป่าลมร้อน 1 เครื่อง
- อุปกรณ์เสริม 1 ชุด (อาจไม่จำเป็นต้องมีอุปกรณ์เสริม)
- คู่มือแนะนำการใช้งาน 1 เล่ม



หากมีชิ้นส่วนขาดหายหรือเสียหาย โปรดติดต่อตัวแทนจำหน่ายของคุณ

คำเตือนด้านความปลอดภัยของเครื่องมือไฟฟ้าทั่วไป

โปรดอ่านคำเตือนด้านความปลอดภัย คำแนะนำ ภาพประกอบ และข้อมูลจำเพาะต่างๆ ที่ให้มาพร้อมกับเครื่องมือไฟฟ้าอย่างละเอียด การไม่ปฏิบัติตามคำแนะนำดังกล่าวนี้อาจส่งผลให้เกิดไฟฟ้าช็อต ไฟไหม้ และ/หรือได้รับบาดเจ็บอย่างร้ายแรงได้

เก็บรักษาคำเตือนและคำแนะนำทั้งหมดไว้

เป็นข้อมูลอ้างอิงในอนาคต

คำว่า “เครื่องมือไฟฟ้า” ในคำเตือนนี้หมายถึงเครื่องมือไฟฟ้า (มีสาย) ที่ทำงานโดยใช้กระแสไฟฟ้าหรือเครื่องมือไฟฟ้า (ไร้สาย) ที่ทำงานโดยใช้แบตเตอรี่

ความปลอดภัยของพื้นที่ทำงาน

1. ดูแลพื้นที่ทำงานให้มีความสะอาดและมีแสงไฟสว่าง พื้นที่ที่กระเบื้องหรือมัตที่บอาจนำไปสู่การเกิดอุบัติเหตุได้
2. อย่าใช้งานเครื่องมือไฟฟ้าในสภาพที่อาจเกิดการระเบิด เช่น ในสถานที่ที่มีของเหลว ก๊าซ หรือฝุ่นผงที่มีคุณสมบัติไวไฟ เครื่องมือไฟฟ้าอาจสร้างประกายไฟและจุดชนวนฝุ่นผงหรือก๊าซดังกล่าว
3. ดูแลไม่ให้มีเด็ก หรือบุคคลอื่นอยู่ในบริเวณที่กำลังใช้เครื่องมือไฟฟ้า การมีสิ่งรบกวนสมาธิอาจทำให้คุณสูญเสียการควบคุม

ความปลอดภัยด้านไฟฟ้า

1. ปลั๊กของเครื่องมือไฟฟ้าต้องพอดีกับเต้ารับ อย่าดัดแปลงปลั๊กไม่ว่ากรณีใดๆ อย่าใช้ปลั๊กอะแดปเตอร์กับเครื่องมือไฟฟ้าที่ต่อสายดิน ปลั๊กที่ไม่ถูกต้องและเต้ารับที่เข้ากันพอดีจะช่วยลดความเสี่ยงของการเกิดไฟฟ้าช็อต
2. ระวังอย่าให้ร่างกายสัมผัสกับพื้นผิวที่ต่อสายดิน เช่น ท่อ เครื่องนำความร้อน เตาหุงต้ม และตู้เย็น มีความเสี่ยงที่จะเกิดไฟฟ้าช็อตสูงขึ้น หากร่างกายของคุณสัมผัสกับพื้น
3. อย่าให้เครื่องมือไฟฟ้าถูกน้ำหรืออยู่ในสภาพเปียกชื้น น้ำที่ไหลเข้าไปในเครื่องมือไฟฟ้าจะเพิ่มความเสี่ยงของการเกิดไฟฟ้าช็อต
4. อย่าใช้สายไฟอย่างไม่เหมาะสม อย่าใช้สายไฟเพื่อยก ดึง หรือถอดปลั๊กเครื่องมือไฟฟ้า เก็บสายไฟให้ห่างจากความร้อน น้ำมัน ของมีคม หรือชิ้นส่วนที่เคลื่อนที่ สายที่ชำรุดหรือพันกันจะเพิ่มความเสี่ยงของการเกิดไฟฟ้าช็อต
5. ขณะที่ใช้งานเครื่องมือไฟฟ้ากลางแจ้ง ควรใช้สายต่อพ่วงที่เหมาะสมกับงานกลางแจ้ง การใช้สาย

ที่เหมาะสมกับงานกลางแจ้งจะลดความเสี่ยงของการเกิดไฟฟ้าช็อต

6. หากต้องใช้งานเครื่องมือไฟฟ้าในสถานที่เปียกชื้น ให้ใช้อุปกรณ์ป้องกันกระแสไฟรั่ว (RCD) การใช้ RCD จะลดความเสี่ยงของการเกิดไฟฟ้าช็อต
7. แนะนำให้ใช้แหล่งจ่ายไฟผ่าน RCD ที่มีกระแสไฟรั่วในอัตราไม่เกิน 30 mA เสมอ
8. เครื่องมือไฟฟ้าอาจสร้างสนามแม่เหล็ก (EMF) ที่ไม่เป็นอันตรายต่อผู้ใช้ อย่างไรก็ตาม ผู้ใช้ที่ใส่เครื่องกระตุ้นหัวใจและอุปกรณ์ทางการแพทย์ที่คล้ายกันนี้ ควรติดต่อผู้ผลิตอุปกรณ์และ/หรือแพทย์เพื่อรับคำแนะนำก่อนใช้งานเครื่องมือไฟฟ้านี้
9. อย่าจับปลั๊กไฟด้วยมือที่เปียก
10. หากสายไฟชำรุด โปรดให้ผู้ผลิตหรือตัวแทนของผู้ผลิตเปลี่ยนให้ เพื่อหลีกเลี่ยงอันตราย

ความปลอดภัยส่วนบุคคล

1. ให้ระมัดระวังและเมสติดอยู่เสมอขณะใช้งานเครื่องมือไฟฟ้า อย่าใช้งานเครื่องมือไฟฟ้าในขณะที่คุณกำลังเหนื่อย หรือในสภาพที่มึนเมาจากยาเสพติด เครื่องดื่มแอลกอฮอล์ หรือการกินยา ช่วงเวลาที่ขาดความระมัดระวังเมื่อกำลังใช้งานเครื่องมือไฟฟ้าอาจทำให้ได้รับบาดเจ็บร้ายแรง
2. ใช้อุปกรณ์ป้องกันส่วนบุคคล สวมแว่นตาป้องกันเสมอ อุปกรณ์ป้องกัน เช่น หน้ากากกันฝุ่น รองเท้านิรภัย กันสั่น หมวกนิรภัย หรือเครื่องป้องกันการได้ยินที่ใช้ในสภาพที่เหมาะสมจะช่วยลดการบาดเจ็บ
3. ป้องกันไม่ให้เกิดการเปิดใช้งานโดยไม่ตั้งใจ ตรวจสอบให้แน่ใจว่าสวิตช์ปิดอยู่ก่อนที่จะเชื่อมต่อกับแหล่งจ่ายไฟ และ/หรือชุดแบตเตอรี่ รวมทั้งตรวจสอบก่อนการยกหรือเคลื่อนย้ายเครื่องมือ การสอดนิ้วมือบริเวณสวิตช์เพื่อถือเครื่องมือไฟฟ้า หรือการชาร์จไฟเครื่องมือไฟฟ้าในขณะที่เปิดสวิตช์อยู่อาจนำไปสู่การเกิดอุบัติเหตุ
4. นำกฎแฉปรับตั้งหรือประกอบออกก่อนที่จะเปิดเครื่องมือไฟฟ้า ประแจหรือกฎแฉที่เสียบค้างอยู่ในชิ้นส่วนที่หมุนได้ของเครื่องมือไฟฟ้าอาจทำให้ได้รับบาดเจ็บ
5. อย่าทำงานในระบะที่สูดเอื้อม จัดท่าการยืนและการทรงตัวให้เหมาะสมตลอดเวลา เพราะจะทำให้ควบคุมเครื่องมือไฟฟ้าได้ดีขึ้นในสถานการณ์ที่ไม่คาดคิด
6. แต่งกายให้เหมาะสม อย่าสวมเครื่องแต่งกายที่หลวมเกินไป หรือสวมเครื่องประดับ ดูแลไม่ให้เส้นผมและเสื้อผ้าอยู่ใกล้ชิ้นส่วนที่เคลื่อนที่ เสื้อผ้ารุ่มร่าม เครื่องประดับ หรือผมที่มีความยาวอาจเข้าไปติดในชิ้นส่วนที่เคลื่อนที่

- หากมีการจัดอุปกรณ์สำหรับดูดและจับฝุ่นไว้ในสถานที่ ให้ตรวจสอบว่าได้เชื่อมต่อและใช้งานอุปกรณ์นั้นอย่างเหมาะสม การใช้เครื่องดูดและจับฝุ่นจะช่วยลดอันตรายที่เกิดจากฝุ่นผงได้
- อย่าให้ความดันเคยจากการใช้งานเครื่องมือเป็นประจำทำให้คุณทำตัวตามสบายและละเลยหลักการเพื่อความปลอดภัยในการใช้เครื่องมือ การกระทำที่ไม่ระมัดระวังอาจทำให้เกิดการบาดเจ็บร้ายแรงภายในเสี้ยววินาที
- สวมใส่แว่นครอบตานิรภัยเพื่อปกป้องดวงตาของคุณจากการบาดเจ็บเมื่อใช้เครื่องมือไฟฟ้า แว่นครอบตาจะต้องได้มาตรฐาน ANSI Z87.1 ในสหรัฐอเมริกา, EN 166 ในยุโรป หรือ AS/NZS 1336 ในออสเตรเลีย/นิวซีแลนด์ ในออสเตรเลีย/นิวซีแลนด์ จะต้องสวมเกราะป้องกันใบหน้าเพื่อปกป้องใบหน้าของคุณอย่างถูกต้องตามกฎหมายด้วย

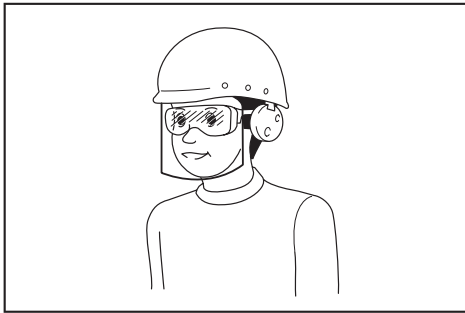

ผู้ว่าจ้างมีหน้าที่รับผิดชอบในการบังคับผู้ใช้งานเครื่องมือและบุคคลอื่น ๆ ที่อยู่บริเวณที่ปฏิบัติงานให้ใช้อุปกรณ์ป้องกันที่เหมาะสม

การใช้และดูแลเครื่องมือไฟฟ้า

- อย่าฝืนใช้เครื่องมือไฟฟ้า ใช้เครื่องมือไฟฟ้าที่เหมาะสมกับการใช้งานของคุณ เครื่องมือไฟฟ้าที่เหมาะสมจะทำให้ได้งานที่มีประสิทธิภาพและปลอดภัยกว่าตามขีดความสามารถของเครื่องที่ได้รับการออกแบบมา
- อย่าใช้เครื่องมือไฟฟ้า หากสวิตช์ไม่สามารถเปิดปิดได้ เครื่องมือไฟฟ้าที่ควบคุมด้วยสวิตช์ไม่ได้เป็นสิ่งอันตรายและต้องได้รับการซ่อมแซม
- ถอดปลั๊กจากแหล่งจ่ายไฟ และ/หรือชุดแบตเตอรี่ออกจากเครื่องมือไฟฟ้าก่อนทำการปรับตั้ง เปลี่ยนอุปกรณ์เสริม หรือจัดเก็บเครื่องมือไฟฟ้า วิธีการป้องกันด้านความปลอดภัยดังกล่าวจะช่วยลดความเสี่ยงในการเปิดใช้งานเครื่องมือไฟฟ้าโดยไม่ตั้งใจ
- จัดเก็บเครื่องมือไฟฟ้าที่ไม่ได้ใช้งานให้ห่างจากมือเด็ก และอย่าอนุญาตให้บุคคลที่ไม่คุ้นเคยกับเครื่องมือไฟฟ้าหรือคำแนะนำเหล่านี้ใช้งานเครื่องมือไฟฟ้า

- เครื่องมือไฟฟ้าจะเป็นอันตรายเมื่ออยู่ในมือของผู้ที่ไม่ได้รับการฝึกอบรม
- บำรุงรักษาเครื่องมือไฟฟ้าและอุปกรณ์เสริม ตรวจสอบการประกอบที่ไม่ถูกต้องหรือการเชื่อมต่อของชิ้นส่วนที่เคลื่อนที่ การแตกหักของชิ้นส่วน หรือสภาพอื่น ๆ ที่อาจส่งผลกระทบต่อการทำงานของเครื่องมือไฟฟ้า หากมีความเสียหาย ให้นำเครื่องมือไฟฟ้าไปซ่อมแซมก่อนการใช้งาน อุบัติเหตุจำนวนมากเกิดจากการดูแลรักษาเครื่องมือไฟฟ้าอย่างไม่ถูกต้อง
- ทำความสะอาดเครื่องมือตัดและลับให้คมอยู่เสมอ เครื่องมือการตัดที่มีการดูแลอย่างถูกต้องและมีขอบการตัดคมมักจะไม่มีปัญหาตัดชิ้นน้อยและควบคุมได้ง่ายกว่า
- ใช้เครื่องมือไฟฟ้า อุปกรณ์เสริม และวัสดุสิ้นเปลือง ฯลฯ ตามคำแนะนำดังกล่าว พิจารณาสภาพการทำงานและงานที่จะลงมือทำ การใช้เครื่องมือไฟฟ้าเพื่อทำงานอื่นนอกเหนือจากที่กำหนดไว้อาจทำให้เกิดอันตราย
- ดูแลมือจับและบริเวณมือจับให้แห้ง สะอาด และไม่มีน้ำมันและจารบีเปื้อน มือจับและบริเวณมือจับที่ลื่นจะทำให้ไม่สามารถจับและควบคุมเครื่องมือได้อย่างปลอดภัยในสถานการณ์ที่ไม่คาดคิด
- ขณะใช้งานเครื่องมือ อย่าสวมใส่ถุงมือผ้าที่อาจเข้าไปติดในเครื่องมือได้ หากถุงมือผ้าเข้าไปติดในชิ้นส่วนที่กำลังเคลื่อนที่ที่อยู่อาจทำให้ได้รับบาดเจ็บ

การซ่อมบำรุง

- นำเครื่องมือไฟฟ้าเข้ารับบริการจากช่างซ่อมที่ผ่านการรับรองโดยใช้อะไหล่แบบเดียวกันเท่านั้น เพราะจะทำให้การใช้เครื่องมือไฟฟ้ามีความปลอดภัย
- ปฏิบัติตามคำแนะนำในการหล่อลื่นและการเปลี่ยนอุปกรณ์เสริม

คำแนะนำด้านความปลอดภัยเพิ่มเติมสำหรับปืนปาล์มร้อน

- ห้ามวางมือของคุณเหนือช่องระบายอากาศหรือปิดช่องระบายอากาศในลักษณะใด ๆ ก็ตาม
- หัวฉีดและอุปกรณ์เสริมของเครื่องมือนี้จะมีร้อนมากในระหว่างการใช้งาน วางชิ้นส่วนเหล่านี้ไว้ให้เย็นลงก่อนที่จะสัมผัส
- ควรจะปิดสวิตช์เครื่องมือก่อนที่จะวางลงทุกครั้ง
- ห้ามวางเครื่องมือทิ้งไว้โดยไม่ดูแลขณะเปิดเครื่องไว้
- อาจเกิดเพลิงไหม้ขึ้น หากไม่ได้ใช้เครื่องมือด้วยความระมัดระวัง
- ความร้อนอาจสัมผัสกับวัสดุที่ติดไฟได้ง่ายที่มองเห็น ห้ามใช้ในสภาวะบรรยากาศที่เปียกชื้น สถานที่ที่

อาจมีก๊าซไวไฟ หรืออยู่ใกล้วัสดุที่ติดไฟได้ง่าย

- วางเครื่องมือไว้ให้เย็นสนิทก่อนทำการจัดเก็บ
- ทำให้แน่ใจว่ามีอากาศหายใจที่พอเพียง เพราะอาจเกิดวันพิษ
- ห้ามใช้เป็นเครื่องเป่าลม
- ห้ามกีดขวางช่องทางเข้าของอากาศหรือช่องระบายอากาศ เพราะอาจทำให้เกิดความร้อนสะสมมากเกินไป ซึ่งจะทำให้เกิดความเสียหายต่อเครื่องมือนี้
- ห้ามเป่าลมร้อนไปที่ผู้อื่นโดยตรง
- ห้ามแตะต้องหัวฉีดโลหะ เพราะจะร้อนมากขณะใช้งาน และจะร้อนต่อเนื่องนานสุดถึง 30 นาทีหลังจากใช้งาน
- ห้ามวางหัวฉีดพ่นกับสิ่งใด ขณะที่ใช้งานหรือทันทีหลังการใช้งาน
- ห้ามแห่สิ่งใดลงในหัวฉีด เพราะอาจทำให้ไฟฟ้าช็อตคุณได้ ห้ามมองลงในหัวฉีดขณะที่เครื่องกำลังทำงาน เนื่องจากเครื่องจะผลิตอุณหภูมิสูง
- ห้ามให้สีติดแน่นกับหัวฉีดหรือเครื่องชูด เนื่องจากอาจทำให้เกิดการลวกไหม้หลังจากผ่านไปสักระยะเวลาหนึ่ง

การกำจัดสี

- ห้ามใช้เครื่องมือนี้เพื่อกำจัดสีที่มีสารตะกั่ว สิ่งที่ลอกออก เศษตกค้างและละอองไอน้ำของสีอาจมีสารตะกั่ว ซึ่งเป็นพิษ อาคารที่สร้างก่อน ค.ศ. 1960 อาจมีการทาสีในอดีตด้วยสีที่มีตะกั่วและทาทับด้วยชั้นสีเพิ่มเติม เมื่อสะสมบนพื้นผิว สารอาจเข้าทางปากจากมือ อาจส่งผลให้เกิดการกลืนกินสารตะกั่ว ถึงแม้จะสัมผัสกับสารตะกั่วในระดับต่ำ ก็อาจเกิดความเสียหายต่อสมองและระบบประสาทที่ไม่สามารถกลับคืนมาได้ เด็กและทารกในครรภ์ที่มีความเสี่ยงเป็นพิเศษ
- เมื่อกำจัดสีออก ทำให้แน่ใจว่าได้ปิดล้อมพื้นที่ทำงาน ควรใส่หน้ากากกันฝุ่น
- ห้ามเผาสี ใช้เครื่องชูดและให้หัวฉีดห่างจากพื้นผิวที่ทาสีอย่างน้อย 25 มม. เมื่อทำงานในทิศทางแนวตั้ง ให้ทำงานลงข้างล่างเพื่อป้องกันไม่ให้สีหล่นลงในเครื่องมือและเกิดการเผาไหม้
- กำจัดเศษสีทั้งหมดอย่างปลอดภัยและทำให้แน่ใจว่าพื้นที่ทำงานสะอาดทั้งหมดหลังจากเสร็จสิ้นการทำงาน

การติดตั้งอุปกรณ์เสริมที่ถูกต้อง (ถ้ามี)

ไอคอน	คำอธิบาย	วัตถุประสงค์
	หัวฉีดป้องกันกระจก	หน้าต่างป้องกันเมื่อลอกกรอบ
	หัวฉีดสะท้อน	ท่อบัดกรี
	หัวฉีดลดขนาด	การเชื่อม การหดของปลอกหุ้ม (ความร้อนเข้มข้นเหนือพื้นที่ขนาดเล็ก)
	หัวฉีดช่องกว้าง	การอบแห้ง การละลาย (กระจายความร้อนทั่วบริเวณที่กว้างขึ้น)
	หัวฉีดการเชื่อมแบบซ้อน	การเชื่อม

ไอคอน	คำอธิบาย	วัตถุประสงค์
	ตัวสะท้อนปลอกบัดกรี	การบัดกรี
	หัวฉีดการเชื่อม	การเชื่อม
	ลูกกลิ้งแรงดัน	กดลงบนพื้นผิวของชิ้นงาน
	เครื่องชุด	การลอกสีและน้ำมันเคลือบเงา



- ตรวจสอบให้แน่ใจว่าได้ปิดเครื่องมือและหัวฉีดเรียบร้อยแล้ว
- หัวฉีดที่หล่นลงอาจจุดไฟวัตถุที่อยู่บนพื้น ต้องติดตั้งหัวฉีดให้แน่นและมั่นคงบนตัวเครื่อง
- การสัมผัสกับหัวฉีดที่ร้อนอาจทำให้เกิดการไหม้อย่างรุนแรงได้ ก่อนที่จะยึดติดหรือเปลี่ยนหัวฉีดควรปล่อยให้เครื่องเย็นลงอย่างสมบูรณ์หรือใช้เครื่องมือที่เหมาะสม
- หัวฉีดที่ร้อนอาจทำให้พื้นผิวเกิดไฟไหม้ได้ วางหัวฉีดที่ร้อนลงบนพื้นผิวที่กันไฟไหม้เท่านั้น
- หัวฉีดที่ไม่ถูกต้องหรือชำรุดอาจทำให้เกิดการสะสมความร้อนและทำให้เครื่องเสียหาย ใช้หัวฉีดของแท้ตามตารางที่เหมาะสมกับเครื่องของคุณเท่านั้น

คำแนะนำสำหรับการใช้งาน



หากคุณไม่แน่ใจเกี่ยวกับการตั้งค่าที่ถูกต้อง ให้เริ่มต้นด้วยการตั้งค่าอุณหภูมิต่ำก่อน และค่อย ๆ เพิ่มอุณหภูมิจนกว่าคุณจะได้ผลลัพธ์ที่ดีที่สุด



ควรปฏิบัติตามคำแนะนำด้านความปลอดภัยและข้อบังคับที่เกี่ยวข้องอยู่เสมอ



ใช้มือข้างเดียวถือเครื่องมือเท่านั้น อย่าวางมืออีกข้างเหนือช่องระบายอากาศ (รูป 1)



ไม่ใช่รูปนตัวเสียบอุปกรณ์เพื่อการป้องกันการหล่นลงมาจากที่สูง

ก่อนการใช้งาน

- ติดตั้งอุปกรณ์เสริมที่ถูกต้องสำหรับการใช้งาน

การเปิดและปิด

- ตัวเลขบนสวิตช์แบบเลื่อนแทนความหมายดังต่อไปนี้

HG6530V:

0: ตำแหน่งปิด

- 1: สำหรับระบายความร้อนด้วยกระแสลมที่อุณหภูมิประมาณ 50°C
- 2: สำหรับทำความร้อนด้วยปริมาตรอากาศต่ำ
- 3: สำหรับทำความร้อนด้วยปริมาตรอากาศสูง

HG6531C:

0: ตำแหน่งปิด

- 1: สำหรับระบายความร้อนด้วยกระแสลมที่อุณหภูมิประมาณ 50°C
- 2: สำหรับทำความร้อน

- ในการเปิดป็นเป่าลมร้อน ให้เลื่อนสวิตช์แบบเลื่อน (1) จาก 0 ไปยังหนึ่งในตำแหน่งเปิด ที่หมายเลข 1 2 หรือ 3
- ในการปิดป็นเป่าลมร้อน ปรับสวิตช์แบบเลื่อนไปยังตำแหน่งที่ 1 เพื่อระบายนความร้อนสักครู่ จากนั้นจึงปรับสวิตช์แบบเลื่อนไปยังตำแหน่งที่ 0 (ปิด)



ป็นเป่าลมร้อนอาจมีควันออกมาบ้างไม่ว่าหลังทำการเปิดสวิตช์ นี้ไม่ได้ชี้ว่าเครื่องมีมีปัญหาแต่อย่างใด

การตั้งค่าอุณหภูมิ (HG6530V)

สามารถตั้งค่าอุณหภูมิด้วยสวิตช์แบบเลื่อน (1) ไปที่ตำแหน่ง 2 หรือ 3

- กด ปุ่มการตั้งค่าอุณหภูมิ + (2b) เพื่อเพิ่มอุณหภูมิ และ - (2a) เพื่อลดอุณหภูมิ หน้าจอ LCD (5) จะแสดงอุณหภูมิปัจจุบันของกระแสมลมไม่กัวินาทีหลังจากตั้งค่าอุณหภูมิเป้าหมาย
- ในการเปลี่ยนหน่วยของอุณหภูมิระหว่าง °C หรือ °F ให้กดปุ่ม + และ - พร้อมกัน

การเลือกโหมดที่ตั้งไว้ล่วงหน้า (HG6531C)

สามารถเลือกโหมดที่ตั้งไว้ล่วงหน้าทั้ง 14 โหมดเพื่อตั้งค่าอุณหภูมิและปริมาตรอากาศได้อย่างรวดเร็วให้เหมาะกับการใช้งานหลักๆ เลือกการใช้งานที่ตั้งไว้ล่วงหน้าตามต้องการด้วยวิธีต่อไปนี้

1. ปรับสวิตช์แบบเลื่อน (1) ไปที่ตำแหน่ง 2 หน้าจอ LCD (5) จะแสดงชื่อการใช้งานครั้งล่าสุดรวมถึงการตั้งค่าอุณหภูมิและปริมาตรอากาศที่สอดคล้องกัน หลังจากนั้นไม่กี่วินาที หน้าจอ LCD จะแสดงอุณหภูมิปัจจุบันของกระแสมลม
2. กดปุ่มตั้งค่าล่วงหน้า (6) ชื่อของการใช้งานจะปรับเปลี่ยนได้
3. กดปุ่มการตั้งค่าอุณหภูมิ (2a/b) หรือปุ่มการตั้งค่าปริมาตรอากาศ (3a/b) เพื่อเลือกการใช้งาน เมื่อชื่อของการใช้งานที่ต้องการแสดงขึ้นบนหน้าจอ LCD กดปุ่มยืนยัน (4) เพื่อตัดสินใจ



เมื่อใดก็ตามที่การตั้งค่าไม่ได้รับการยืนยันด้วยการกดปุ่มยืนยัน (4) ภายใน 5-6 วินาที เครื่องมือจะคืนค่ากลับไปยังการตั้งค่าที่ยืนยันครั้งก่อนหน้า

การตั้งค่าอุณหภูมิและปริมาตรอากาศ (HG6531C)

เปลี่ยนค่าอุณหภูมิและปริมาตรอากาศด้วยวิธีต่อไปนี้ เมื่อสวิตช์แบบเลื่อน (1) อยู่ในตำแหน่งที่ 1 จะเปลี่ยนได้เฉพาะค่าปริมาตรอากาศเท่านั้น



เมื่อสวิตช์แบบเลื่อนอยู่ในตำแหน่งที่ 2 ขั้นตอนนี้จะเขียนทับอุณหภูมิและปริมาตรอากาศที่ตั้งไว้ล่วงหน้าของการใช้งานปัจจุบันที่แสดงบนหน้าจอ LCD

1. ปรับสวิตช์แบบเลื่อน (1) ไปที่ตำแหน่ง 1 หรือ 2
2. กดปุ่มการตั้งค่าอุณหภูมิ (2a/b) เพื่อเปลี่ยนค่าอุณหภูมิ กดปุ่มการตั้งค่าปริมาตรอากาศ (3a/b) เพื่อเปลี่ยนค่าปริมาตรอากาศ ส่วนที่แสดงอุณหภูมิและปริมาตรอากาศบนหน้าจอ LCD (5) จะเริ่มกระพริบ
3. กดปุ่มยืนยัน (4) เพื่อยืนยันการตั้งค่า ค่าอุณหภูมิและปริมาตรอากาศบนหน้าจอ LCD จะหยุดกระพริบ หลังจากนั้นไม่กี่วินาที หน้าจอ LCD จะแสดงอุณหภูมิปัจจุบันของกระแสมลม



เมื่อใดก็ตามที่การตั้งค่าไม่ได้รับการยืนยันด้วยการกดปุ่มยืนยัน (4) ภายใน 5-6 วินาที เครื่องมือจะคืนค่ากลับไปยังการตั้งค่าที่ยืนยันก่อนหน้า

การตั้งค่าภาษาที่แสดงและหน่วยของอุณหภูมิ (HG6531C)

1. ปรับสวิตช์แบบเลื่อน (1) ไปยังตำแหน่งที่ 1/2
2. กดปุ่มตั้งค่าล่วงหน้า (6) ค้างไว้จนกว่าแถบภาษาจะกระพริบ
3. ในการเปลี่ยนหน่วยของอุณหภูมิระหว่าง °C หรือ °F ให้กดปุ่มการตั้งค่าอุณหภูมิ (2a/b) ในการเปลี่ยนภาษา กดปุ่มการตั้งค่าปริมาตรอากาศ (3a/b) เลือกได้ทั้งหมด 10 ภาษา: อังกฤษ เยอรมัน อิตาลี ฝรั่งเศส สเปน โปรตุเกส ดัตช์ สวิตซ์ ชาวจีน และ ญี่ปุ่น
4. กดปุ่มยืนยัน (4) เพื่อตัดสินใจการตั้งค่าของคุณ

ฝาครอบด้านหน้าถอดออกได้

- สามารถถอดฝาครอบด้านหน้าออกได้เมื่อทำงานในพื้นที่แคบ



ระวังหัวฉีดที่ร้อน
การถอดฝาครอบด้านหน้าจะเพิ่มความเสี่ยงต่อการไหม้กับหัวฉีดเปลี่ยนที่ร้อน

การลอกสี

- ติดตั้งอุปกรณ์เสริมที่เหมาะสม
- ตั้งอุณหภูมิอากาศสูง
- เปิดเครื่องมือ
- จ่อลมร้อนลงบนสีที่ต้องการขจัดออก
- เมื่อสีอ่อนลง ขูดสีออกไปโดยใช้เครื่องขูดด้วยมือ

 ห้ามลอกกรอบหน้าต่างโลหะ เนื่องจาก ความร้อนอาจเป็นสื่อนำความร้อนบน กระจกและทำให้แตกร้าวได้ เมื่อลอกกรอบ หน้าต่างอื่น ๆ ให้ใช้หัวคีบป้องกันกระจก อย่าให้เครื่องมือจ่ออยู่ที่จุดใดจุดหนึ่งนาน เกินไปเพื่อป้องกันการจุดติดไฟที่พื้นผิว

 หลีกเลี่ยงการสะสมของสียบนอุปกรณ์เสริม การขีด เนื่องจากอาจทำให้จุดติดไฟได้ ถ้า จำเป็นให้กำจัดเศษสีออกจากอุปกรณ์เสริม การขีดอย่างระมัดระวังโดยใช้มีด

การใช้งานแบบอยู่กับที่

- เครื่องมือนี้สามารถใช้ใหม่ต่อกับที่ได้เช่นกัน
- วางเครื่องมือไว้บนโต๊ะทำงานที่มั่นคง
 - ยึดสายให้แน่นเพื่อป้องกันไม่ให้ดึงเครื่องมือออกจาก โต๊ะทำงาน
 - เปิดเครื่องมืออย่างระมัดระวัง

 โปรดตรวจสอบให้แน่ใจว่าหัวคีบยึดเข้าไปให้แน่น จากตัวคุณและผู้ที่อยู่รอบข้างเสมอ

 ตรวจสอบให้แน่ใจว่าไม่มีการหยอดสิ่งใด ลงในหัวคีบ

การระบายความร้อน

- หัวคีบและอุปกรณ์เสริมจะร้อนมากระหว่างการใช้งาน ปลดออก ให้เครื่องเย็นลงก่อนที่จะพยายามย้ายหรือจัดเก็บเครื่องมือ
- เพื่อลดเวลาในการเย็นลง ให้เปิดสวิตช์เครื่องที่ตำแหน่งลมที่ต่ำที่สุดและปล่อยให้เครื่องทำงานเป็นเวลา สองถึงสามนาที
 - ปิดเครื่องมือและปล่อยให้เย็นลงอย่างน้อย 30 นาที วางในแนวตั้งและตั้งไว้เสมอ

 เมื่อภายในเป็นปาล์มร้อนมีอุณหภูมิสูงเกินไป ส่วนแสดงสถานะที่ LCD จะกะพริบ ในกรณีดังกล่าว ให้ปรับสวิตช์เลื่อนไปที่ ตำแหน่ง 1 เพื่อให้เครื่องมือเย็นลง หลังจากที่ยืนลงอย่างสมบูรณ์แล้ว ให้เริ่มใช้งานอีกครั้ง

ถ้า LCD ยังคงกะพริบหลังจากเริ่มการทำงานใหม่ โปรดติดต่อศูนย์บริการ Makita ในท้องถิ่นของคุณ

การบำรุงรักษาและการทำความสะอาด

 **ข้อควรระวัง:** ก่อนดำเนินการงานใด ๆ ที่ อุปกรณ์ ให้ดึงปลั๊กไฟออกก่อน

การบำรุงรักษา

- เครื่องมือไฟฟ้าของคุณได้รับการออกแบบเพื่อให้ใช้งานได้ในระยะเวลานานโดยมีการบำรุงรักษาที่น้อยที่สุด การดำเนินการที่นำพาไปอย่างต่อเนื่องขึ้นอยู่กับ การดูแลรักษาเครื่องมือและการทำความสะอาดอย่างเหมาะสม

การหล่อลื่น

- เครื่องมือไฟฟ้าของคุณไม่จำเป็นต้องใช้สารหล่อลื่นเพิ่มเติม

การทำความสะอาด

- รักษาช่องระบายอากาศของเครื่องให้สะอาดและปราศจากฝุ่นและสิ่งสกปรกอยู่เสมอ เพื่อป้องกันไม่ให้มอเตอร์ร้อนจนเกินไป
- ทำความสะอาดปลอกหุ้มเครื่องด้วยผ้านุ่มอยู่เสมอ โดยเฉพาะอย่างยิ่งหลังจากใช้งานทุกครั้ง ถ้าหากสิ่งสกปรกไม่หลุดออกมา ให้ใช้ผ้านุ่มชุบน้ำสบู่หมาด ๆ

 ห้ามใช้สารทำลาย เช่น เบนซิน แอลกอฮอล์ น้ำแอมโมเนีย ฯลฯ สารทำลายเหล่านี้อาจทำให้ชิ้นส่วนพลาสติกเกิดความเสียหายได้

ข้อมูลด้านเทคนิค

หมายเลขรุ่น:	HG6531C	HG6530V
แรงดันไฟฟ้า	220-240V-50Hz	220-240V-50Hz
กำลังงาน	2000W	2000W
อุณหภูมิกระแสมล	I 50°C	500L/M
	II 50-650°C	200-550L/M
	III 50-650°C	280L/M
		550L/M
ความยาวโดยรวม	257mm.	257mm.
น้ำหนักสุทธิ	0.71kg.	0.72kg.

การตั้งค่าเริ่มต้นของโหมดที่ตั้งไว้ล่วงหน้า

หมายเลข	ชื่อการใช้งาน	อุณหภูมิ	ปริมาตรอากาศ
1	ตั้งค่าอิสระ 1	250°C	5
2	ตั้งค่าอิสระ 2	500°C	5
3	การหดตัว	300°C	3
4	การขึ้นรูป	250°C	4
5	การบัดกรีทองแดง	650°C	3
6	การปาสีให้แห้ง	650°C	5

หมายเลข	ชื่อการใช้งาน	อุณหภูมิ	ปริมาตรอากาศ
7	การลอกสี	450°C	5
8	การเชื่อมฟอยล์พื้น	450°C	3
9	การเชื่อม PPEPDM	280°C	3
10	การเชื่อม HDPE	300°C	3
11	การเชื่อม PP	320°C	3
12	การเชื่อม PVC-U	340°C	3
13	การเชื่อม ABS	360°C	3
14	การเชื่อม PC	380°C	3

สิ่งแวดล้อม



ถ้าเครื่องมือของคุณจำเป็นต้องเปลี่ยนหลังจากใช้งานจนหมดสภาพ อย่าทิ้งอุปกรณ์เหล่านี้ไปพร้อมกับขยะในครัวเรือน แต่ควรกำจัดทิ้งด้วยวิธีที่ปลอดภัยต่อสิ่งแวดล้อม

ไม่ควรจัดการขยะที่เกิดจากรายการเครื่องใช้ไฟฟ้าเหมือนขยะในครัวเรือนทั่วไป โปรดรีไซเคิลในที่ที่มีสิ่งอำนวยความสะดวกอยู่ ตรวจสอบกับหน่วยงานท้องถิ่นหรือร้านค้าปลีกของคุณ เพื่อขอคำแนะนำในการรีไซเคิล

สามารถเปลี่ยนแปลงได้โดยไม่ต้องแจ้งให้ทราบล่วงหน้า

Makita Europe N.V. Jan-Baptist Vinkstraat 2,
3070 Kortenberg, Belgium

Makita Corporation 3-11-8, Sumiyoshi-cho,
Anjo, Aichi 446-8502 Japan

www.makita.com