

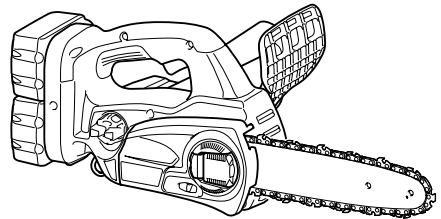

INSTRUCTION MANUAL

# Cordless Chain Saw

DUC252  
DUC302



014676

**IMPORTANT:** Read Before Using.

## ENGLISH (Original instructions)

# SPECIFICATIONS

Model		DUC252		DUC302
Standard guide bar	Guide bar length	250 mm		300 mm
	Cutting length	23 cm	24 cm	28 cm
	Type	Sprocket nose bar	Carving bar	Sprocket nose bar
Standard saw chain	Type	91PX	25AP	90PX
	Pitch	9.5 mm (3/8")	6.35 mm (1/4")	9.5 mm (3/8")
	Gauge	1.3 mm (0.05")	1.3 mm (0.05")	1.1 mm (0.043")
	No. of drive links	40	60	46
Sprocket	Number of teeth	6	9	6
	Pitch	9.5 mm (3/8")	6.35 mm (1/4")	9.5 mm (3/8")
	Overall length (without guide bar)	316 mm		
Net weight	*1	4.1 kg		
	*2	4.6 kg	4.7 kg	
Chain speed per minute		8.3 m/s (500 m/min)		
Chain oil tank volume		85 cm <sup>3</sup>		
Rated voltage		D.C. 36 V		D.C. 36 V

\* Due to our continuing program of research and development, the specifications herein are subject to change without notice.

\* Specifications and battery cartridge may differ from country to country.

\*1 Weight, with largest battery cartridge, without guide bar and chain, empty oil tank, according to EN ISO 11681-2.

\*2 Weight, with battery cartridge, guide bar, and chain, filled oil tank, according to EPTA-Procedure 01/2003.

WARNING: Use appropriate combination of the guide bar and saw chain. Otherwise personal injury may result.

END313-1

## Symbols

The following show the symbols used for the equipment.

Be sure that you understand their meaning before use.



- Read instruction manual.



- Wear eye protection.



- Wear ear protection.



- Wear a helmet, goggles and ear protection.



- Use appropriate protection for foot-leg and hand-arm.



- This saw is to be used by properly trained operators only.



- Do not expose to rain.



- Maximum permissible cut length



- Direction of chain travel



- Saw chain oil adjustment



- Only for EU countries  
Do not dispose of electric equipment or battery pack together with household waste material!

In observance of the European Directives, on Waste Electric and Electronic Equipment and Batteries and Accumulators and Waste Batteries and Accumulators and their implementation in accordance with national laws, electric equipment and batteries and battery pack(s) that have reached the end of their life must be collected separately and returned to an environmentally compatible recycling facility.

ENE090-1

## Intended use

The tool is intended for cutting branches / pruning trees. It is also suitable for tree service.

EN6905-1

## Noise

The typical A-weighted noise level determined according to EN60745:

Sound pressure level ( $L_{pA}$ ) : 84.4 dB (A)

Sound power level ( $L_{WA}$ ) : 95.4 dB (A)

Uncertainty (K) : 2.5 dB (A)

## Wear ear protection

ENG900-1

## Vibration

The vibration total value (tri-axial vector sum) determined according to EN60745:

### Model DUC252

Work mode : cutting wood  
Vibration emission ( $a_h$ ) : 4.7 m/s<sup>2</sup>  
Uncertainty (K) : 1.5 m/s<sup>2</sup>

### Model DUC302

Work mode : cutting wood  
Vibration emission ( $a_h$ ) : 6.3 m/s<sup>2</sup>  
Uncertainty (K) : 1.5 m/s<sup>2</sup>

ENG901-1

- The declared vibration emission value has been measured in accordance with the standard test method and may be used for comparing one tool with another.
- The declared vibration emission value may also be used in a preliminary assessment of exposure.

## WARNING:

- The vibration emission during actual use of the power tool can differ from the declared emission value depending on the ways in which the tool is used.
- Be sure to identify safety measures to protect the operator that are based on an estimation of exposure in the actual conditions of use (taking account of all parts of the operating cycle such as the times when the tool is switched off and when it is running idle in addition to the trigger time).

ENH030-5

## For European countries only

### EC Declaration of Conformity

**Makita declares that the following Machine(s):**

Designation of Machine:

Cordless Chain Saw

Model No./ Type: DUC252, DUC302

Specifications: see "SPECIFICATIONS" table.

**Conforms to the following European Directives:**

2000/14/EC, 2006/42/EC

They are manufactured in accordance with the following standard or standardized documents:

EN ISO 11682-2

The EC-Type Examination Certificate No.4814056.14007

The EC-Type Examination per 2006/42/EC was performed by:

DEKRA Testing and Certification GmbH  
Enderstraße 92b  
01277 Dresden  
Germany  
Identification No. 2140

The technical file in accordance with 2006/42/EC is available from:

Makita, Jan-Baptist Vinkstraat 2, 3070, Belgium

The conformity assessment procedure required by Directive 2000/14/EC was in Accordance with annex V. Measured Sound Power Level: 95.4 dB (A) Guaranteed Sound Power Level: 98 dB (A)

23.9.2014



000331

Yasushi Fukaya  
Director

Makita, Jan-Baptist Vinkstraat 2, 3070, Belgium

GEA006-2

## General Power Tool Safety Warnings

 **WARNING** Read all safety warnings and all instructions. Failure to follow the warnings and instructions may result in electric shock, fire and/or serious injury.

## Save all warnings and instructions for future reference.

The term "power tool" in the warnings refers to your mains-operated (corded) power tool or battery-operated (cordless) power tool.

### Work area safety

1. **Keep work area clean and well lit.** Cluttered or dark areas invite accidents.
2. **Do not operate power tools in explosive atmospheres, such as in the presence of flammable liquids, gases or dust.** Power tools create sparks which may ignite the dust or fumes.
3. **Keep children and bystanders away while operating a power tool.** Distractions can cause you to lose control.

### Electrical safety

4. **Power tool plugs must match the outlet. Never modify the plug in any way. Do not use any adapter plugs with earthed (grounded) power tools.** Unmodified plugs and matching outlets will reduce risk of electric shock.
5. **Avoid body contact with earthed or grounded surfaces such as pipes, radiators, ranges and refrigerators.** There is an increased risk of electric shock if your body is earthed or grounded.

6. **Do not expose power tools to rain or wet conditions.** Water entering a power tool will increase the risk of electric shock.
7. **Do not abuse the cord. Never use the cord for carrying, pulling or unplugging the power tool. Keep cord away from heat, oil, sharp edges or moving parts.** Damaged or entangled cords increase the risk of electric shock.
8. **When operating a power tool outdoors, use an extension cord suitable for outdoor use.** Use of a cord suitable for outdoor use reduces the risk of electric shock.
9. **If operating a power tool in a damp location is unavoidable, use a ground fault circuit interrupter (GFCI) protected supply.** Use of an GFCI reduces the risk of electric shock.

#### Personal safety

10. **Stay alert, watch what you are doing and use common sense when operating a power tool. Do not use a power tool while you are tired or under the influence of drugs, alcohol or medication.** A moment of inattention while operating power tools may result in serious personal injury.
11. **Use personal protective equipment. Always wear eye protection.** Protective equipment such as dust mask, non-skid safety shoes, hard hat, or hearing protection used for appropriate conditions will reduce personal injuries.
12. **Prevent unintentional starting. Ensure the switch is in the off-position before connecting to power source and/or battery pack, picking up or carrying the tool.** Carrying power tools with your finger on the switch or energising power tools that have the switch on invites accidents.
13. **Remove any adjusting key or wrench before turning the power tool on.** A wrench or a key left attached to a rotating part of the power tool may result in personal injury.
14. **Do not overreach. Keep proper footing and balance at all times.** This enables better control of the power tool in unexpected situations.
15. **Dress properly. Do not wear loose clothing or jewellery. Keep your hair, clothing, and gloves away from moving parts.** Loose clothes, jewellery or long hair can be caught in moving parts.
16. **If devices are provided for the connection of dust extraction and collection facilities, ensure these are connected and properly used.** Use of dust collection can reduce dust-related hazards.

#### Power tool use and care

17. **Do not force the power tool. Use the correct power tool for your application.** The correct power tool will do the job better and safer at the rate for which it was designed.
18. **Do not use the power tool if the switch does not turn it on and off.** Any power tool that cannot be controlled with the switch is dangerous and must be repaired.
19. **Disconnect the plug from the power source and/or the battery pack from the power tool before making any adjustments, changing accessories, or storing power tools.** Such preventive safety measures reduce the risk of starting the power tool accidentally.
20. **Store idle power tools out of the reach of children and do not allow persons unfamiliar with the power tool or these instructions to operate the power tool.** Power tools are dangerous in the hands of untrained users.
21. **Maintain power tools. Check for misalignment or binding of moving parts, breakage of parts and any other condition that may affect the power tool's operation. If damaged, have the power tool repaired before use.** Many accidents are caused by poorly maintained power tools.
22. **Keep cutting tools sharp and clean.** Properly maintained cutting tools with sharp cutting edges are less likely to bind and are easier to control.
23. **Use the power tool, accessories and tool bits etc. in accordance with these instructions, taking into account the working conditions and the work to be performed.** Use of the power tool for operations different from those intended could result in a hazardous situation.

#### Battery tool use and care

24. **Recharge only with the charger specified by the manufacturer.** A charger that is suitable for one type of battery pack may create a risk of fire when used with another battery pack.
25. **Use power tools only with specifically designated battery packs.** Use of any other battery packs may create a risk of injury and fire.
26. **When battery pack is not in use, keep it away from other metal objects, like paper clips, coins, keys, nails, screws or other small metal objects, that can make a connection from one terminal to another.** Shorting the battery terminals together may cause burns or a fire.
27. **Under abusive conditions, liquid may be ejected from the battery; avoid contact. If contact accidentally occurs, flush with water. If liquid contacts eyes, additionally seek medical help.** Liquid ejected from the battery may cause irritation or burns.

## Service

28. **Have your power tool serviced by a qualified repair person using only identical replacement parts.** This will ensure that the safety of the power tool is maintained.
29. **Follow instruction for lubricating and changing accessories.**
30. **Keep handles dry, clean and free from oil and grease.**

GEB118-1

## Cordless Chain saw safety warnings:

1. **Keep all parts of the body away from the saw chain when the chain saw is operating. Before you start the chain saw, make sure the saw chain is not contacting anything.** A moment of inattention while operating chain saws may cause entanglement of your clothing or body with the saw chain.
2. **When holding with both hands, always hold the chain saw with your right hand on the rear handle and your left hand on the front handle.** Holding the chain saw with a reversed hand configuration increases the risk of personal injury and should never be done.
3. **Hold the power tool by insulated gripping surfaces only, because the saw chain may contact hidden wiring.** Saw chains contacting a "live" wire may make exposed metal parts of the power tool "live" and could give the operator an electric shock.
4. **Wear safety glasses and hearing protection. Further protective equipment for head, hands, legs and feet is recommended.** Adequate protective clothing will reduce personal injury by flying debris or accidental contact with the saw chain.
5. **Always keep proper footing.** Slippery or unstable surfaces may cause a loss of balance or control of the chain saw.
6. **When cutting a limb that is under tension be alert for spring back.** When the tension in the wood fibers is released the spring loaded limb may strike the operator and/or throw the chain saw out of control.
7. **Use extreme caution when cutting brush and saplings.** The slender material may catch the saw chain and be whipped toward you or pull you off balance.
8. **Carry the chain saw by the front handle with the chain saw switched off and away from your body. When transporting or storing the chain saw always fit the guide bar cover.**

Proper handling of the chain saw will reduce the likelihood of accidental contact with the moving saw chain.

9. **Follow instructions for lubricating, chain tensioning and changing accessories.** Improperly tensioned or lubricated chain may either break or increase the chance for kickback.
10. **Keep handles dry, clean, and free from oil and grease.** Greasy, oily handles are slippery causing loss of control.
11. **Cut wood only. Do not use chain saw for purposes not intended. For example: do not use chain saw for cutting plastic, masonry or non-wood building materials.** Use of the chain saw for operations different than intended could result in a hazardous situation.

12. **Causes and operator prevention of kickback:**

Kickback may occur when the nose or tip of the guide bar touches an object, or when the wood closes in and pinches the saw chain in the cut.

Tip contact in some cases may cause a sudden reverse reaction, kicking the guide bar up and back towards the operator.

Pinching the saw chain along the top of the guide bar may push the guide bar rapidly back towards the operator.

Either of these reactions may cause you to lose control of the saw which could result in serious personal injury. Do not rely exclusively upon the safety devices built into your saw. As a chain saw user, you should take several steps to keep your cutting jobs free from accident or injury.

Kickback is the result of tool misuse and/or incorrect operating procedures or conditions and can be avoided by taking proper precautions as given below:

- **Maintain a firm grip, with thumbs and fingers encircling the chain saw handles, with both hands on the saw and position your body and arm to allow you to resist kickback forces.** Kickback forces can be controlled by the operator, if proper precautions are taken. Do not let go of the chain saw.

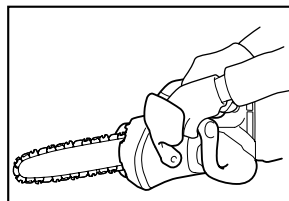

014673

- **Do not overreach and do not cut above shoulder height.** This helps prevent unintended tip contact and enables better control of the chain saw in unexpected situations.
  - **Only use replacement bars and chains specified by the manufacturer.** Incorrect replacement bars and chains may cause chain breakage and/or kickback.
  - **Follow the manufacturer's sharpening and maintenance instructions for the saw chain.** Decreasing the depth gauge height can lead to increased kickback.
13. Before starting work, check that the chain saw is in proper working order and that its condition complies with the safety regulations. Check in particular that:
- The chain brake is working properly;
  - The run-down brake is working properly;
  - The bar and the sprocket cover are fitted correctly;
  - The chain has been sharpened and tensioned in accordance with the regulations;
14. **Do not start the chain saw with the chain cover being installed on it.** Starting the chain saw with the chain cover being installed on it may cause the chain cover to thrown out forward resulting in personal injury and damage to objects around the operator.

### Top handle chainsaw specific safety warnings

1. This chain saw is designed especially for tree care and surgery. The chain saw is intended to be used by properly trained persons only. Observe all instructions, procedures and recommendations from the relevant professional organization. Otherwise fatal accidents may occur. It is recommend that always using a rising platform (cherry picker, lift) for sawing in trees. Rappelling techniques are extremely dangerous and require special training. The operators must be trained to become familiar with safety equipment usage and climbing techniques. Always use the appropriate belts, ropes and carabiners when working in trees. Always use restraining equipment for both the operator and the saw.
  2. Perform cleaning and maintenance before storage in accordance with the instruction manual.
  3. Ensure safe positioning of the chain saw during car transportation to avoid fuel or chain oil leakage, damage to the tool and personal injury.
  4. Regularly check the functionality of chain brake.
  5. Do not fill the chain oil near fire. Never smoke when you fill the chain oil.
6. National regulation may restrict the use of the chain saw.
  7. If the equipment gets heavy impact or fall, check the condition before continuing work. Check the controls and safety devices for malfunction. If there is any damage or doubt, ask our authorized service center for the inspection and repair.
  8. Always activate the chain brake before starting the chain saw.
  9. Hold the saw firmly in place to avoid skating (skid movement) or bouncing of the saw when starting a cut.
  10. At the end of the cut, be careful to keep your balance due to the "drop".
  11. Take into account the direction and speed of the wind. Avoid sawdust and chain oil mist.

### Protective equipment

1. **In order to avoid head, eye, hand or foot injuries as well as to protect your hearing the following protective equipment must be used during operation of the chain saw:**
  - The kind of clothing should be appropriate, i. e. it should be tight-fitting but not be a hindrance. Do not wear jewelry or clothing which could become entangled with bushes or shrubs. If you have long hair, always wear a hairnet!
  - It is necessary to wear a protective helmet whenever working with the chain saw. The **protective helmet** is to be checked in regular intervals for damage and is to be replaced after 5 years at the latest. Use only approved protective helmets.
  - The **face shield** of the protective helmet (or the goggles) protects against sawdust and wood chips. During operation of the chain saw always wear a goggle or a face shield to prevent eye injuries.
  - Wear adequate **noise protection equipment**. (ear muffs, ear plugs, etc.)
  - The **protective jacket** consists of 22 layers of nylon and protects the operator against cuts. It is always to be worn when working from elevated platforms (cherry pickers, lifts), from platforms mounted on ladders or when climbing with ropes.
  - The **protective brace and bib overall** is made of a nylon fabric with 22 layers and protects against cuts. We strongly recommend its use.
  - **Protective gloves** made of thick leather are part of the prescribed equipment and must always be worn during operation of the chain saw.

- During operation of the chain saw **safety shoes** or **safety boots** fitted with anti skid sole, steel toe caps and protection for the leg must always to be worn. Safety shoes equipped with a protective layer provide protection against cuts and ensure a secure footing. For working in trees the safety boots must be suitable for climbing techniques.

#### Vibration

1. Individuals with poor circulation who are exposed to excessive vibration may experience injury to blood vessels or the nervous system. Vibration may cause the following symptoms to occur in the fingers, hands or wrists: "Falling asleep" (numbness), tingling, pain, stabbing sensation, alteration of skin colour or of the skin. **If any of these symptoms occur, see a physician!** To reduce the risk of "white finger disease", keep your hands warm during operation and well maintain the equipment and accessories.

## SAVE THESE INSTRUCTIONS.

### **⚠WARNING:**

**DO NOT** let comfort or familiarity with product (gained from repeated use) replace strict adherence to safety rules for the subject product. **MISUSE** or failure to follow the safety rules stated in this instruction manual may cause serious personal injury.

ENC007-8

## IMPORTANT SAFETY INSTRUCTIONS

### FOR BATTERY CARTRIDGE

1. Before using battery cartridge, read all instructions and cautionary markings on (1) battery charger, (2) battery, and (3) product using battery.
2. Do not disassemble battery cartridge.
3. If operating time has become excessively shorter, stop operating immediately. It may result in a risk of overheating, possible burns and even an explosion.
4. If electrolyte gets into your eyes, rinse them out with clear water and seek medical attention right away. It may result in loss of your eyesight.
5. Do not short the battery cartridge:
  - (1) Do not touch the terminals with any conductive material.
  - (2) Avoid storing battery cartridge in a container with other metal objects such as nails, coins, etc.
  - (3) Do not expose battery cartridge to water or rain.

**A battery short can cause a large current flow, overheating, possible burns and even a breakdown.**
6. Do not store the tool and battery cartridge in locations where the temperature may reach or exceed 50 ° C (122 ° F).
7. Do not incinerate the battery cartridge even if it is severely damaged or is completely worn out. The battery cartridge can explode in a fire.
8. Be careful not to drop or strike battery.
9. Do not use a damaged battery.
10. Follow your local regulations relating to disposal of battery.

## SAVE THESE INSTRUCTIONS.

### Tips for maintaining maximum battery life

1. Charge the battery cartridge before completely discharged. Always stop tool operation and charge the battery cartridge when you notice less tool power.
2. Never recharge a fully charged battery cartridge. Overcharging shortens the battery service life.
3. Charge the battery cartridge with room temperature at 10 ° C - 40 ° C (50 ° F - 104 ° F). Let a hot battery cartridge cool down before charging it.
4. Charge the battery cartridge once in every six months if you do not use it for a long period of time.

# PARTS DESCRIPTION

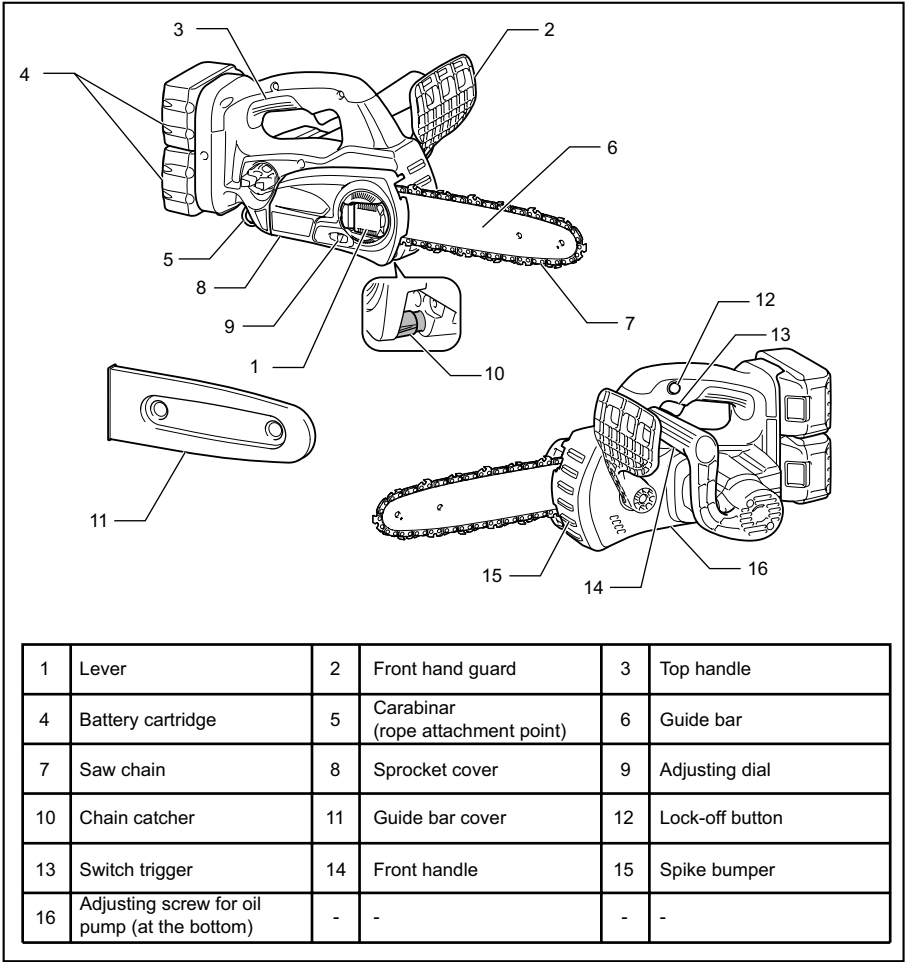

1	Lever	2	Front hand guard	3	Top handle
4	Battery cartridge	5	Carabiner (rope attachment point)	6	Guide bar
7	Saw chain	8	Sprocket cover	9	Adjusting dial
10	Chain catcher	11	Guide bar cover	12	Lock-off button
13	Switch trigger	14	Front handle	15	Spike bumper
16	Adjusting screw for oil pump (at the bottom)	-	-	-	-

014648



## FUNCTIONAL DESCRIPTION

### ⚠CAUTION:

- Always be sure that the tool is switched off and the battery cartridge is removed before adjusting or checking function on the tool.

### Installing or removing battery cartridge

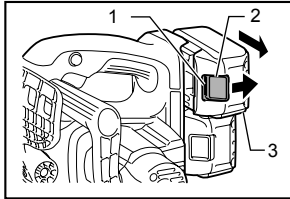

1. Red indicator
2. Button
3. Battery cartridge

014650

### ⚠CAUTION:

- Always switch off the tool before installing or removing of the battery cartridge.
- **Hold the tool and the battery cartridge firmly when installing or removing battery cartridge.** Failure to hold the tool and the battery cartridge firmly may cause them to slip off your hands and result in damage to the tool and battery cartridge and a personal injury.

To remove the battery cartridge, slide it from the tool while sliding the button on the front of the cartridge.

To install the battery cartridge, align the tongue on the battery cartridge with the groove in the housing and slip it into place. Insert it all the way until it locks in place with a little click. If you can see the red indicator on the upper side of the button, it is not locked completely.

### ⚠CAUTION:

- Always install the battery cartridge fully until the red indicator cannot be seen. If not, it may accidentally fall out of the tool, causing injury to you or someone around you.
- Do not install the battery cartridge forcibly. If the cartridge does not slide in easily, it is not being inserted correctly.

### NOTE:

- The tool does not work with only one battery cartridge.

### Tool / battery protection system

The tool is equipped with a tool/battery protection system. This system automatically cuts off power to the motor to extend tool and battery life.

The tool will automatically stop during operation if the tool or battery are placed under one of the following conditions. In some conditions, the indicators light up.

### Overload protection

When the tool is operated in a manner that causes it to draw an abnormally high current, the tool automatically stops without any indication. In this situation, turn the tool off and stop the application that caused the tool to become overloaded. Then turn the tool on to restart.

### Overheat protection for battery / tool

When the battery / tool is overheated, the tool stops automatically without any indication. The tool does not start even if pulling the switch trigger. In this situation, let the battery / tool cool before turning the tool on again.

### NOTE:

The battery overheat protection works only with a battery cartridge with a star marking.

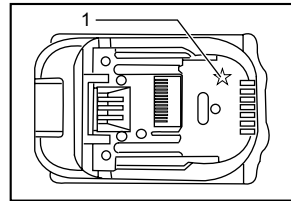

1. Star marking

012128

### Overdischarge protection

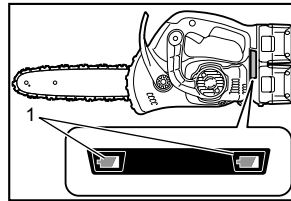

1. Battery indicator

014658

When the remaining battery capacity gets low, the battery indicator blinks on the applicable battery side. By further use, the tool stops and the battery indicator lights up about 10 seconds. In this situation, charge the battery cartridge.

### Switch action

### ⚠CAUTION:

- Before installing the battery cartridge into the tool, always check to see that the switch trigger actuates properly and returns to the "OFF" position when released.

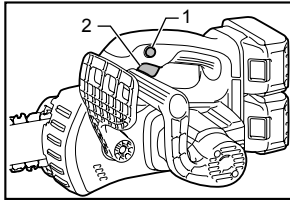

1. Lock-off button
2. Switch trigger

014662

To prevent the switch trigger from being accidentally pulled, a lock-off button is provided.

To start the tool, depress the lock-off button and pull the switch trigger. Release the switch trigger to stop.

### Checking the chain brake

#### NOTE:

- If the chain saw fails to start, the chain brake must be released. Pull the front hand guard backwards firmly until you feel it engage.

Hold the chain saw with both hands when switching it on. Hold the top handle with your right hand, the front handle with your left. The bar and the chain must not be in contact with any object.

First press the lock-off button, then the switch trigger. The saw chain starts immediately.

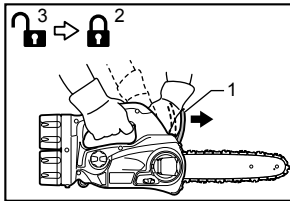

1. Front hand guard
2. Lock
3. Unlock

014663

Press the front hand guard forwards using the back of your hand. The saw chain must come to an immediate standstill.

#### ⚠CAUTION:

- Should the saw chain not stop immediately when this test is performed, the saw may not be used under any circumstances. Consult a MAKITA specialist repair shop.

### Checking the run-down brake

Switch on the chain saw.

Release the switch trigger completely. The saw chain must come to a standstill within one second.

#### ⚠CAUTION:

- Should the saw chain not come to a stop within one second when this test is performed, the saw must not be used. Consult a MAKITA specialist repair shop.

### Adjusting the chain lubrication

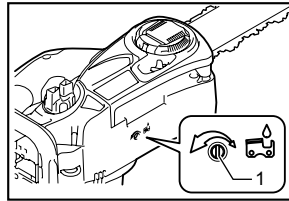

1. Adjusting screw

014656

You can adjust the oil pump feed rate with the adjusting screw. The amount of oil can be adjusted using the universal wrench.

### Carabiner (rope attachment point)

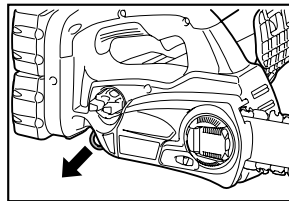

014664

Carabiner (Rope attachment point) is for use of tool hanging. Before using carabiner, pull it out and tie it with a rope.

## ASSEMBLY

#### ⚠CAUTION:

- Always be sure that the tool is switched off and the battery cartridge is removed before carrying out any work on the tool.

### Removing or installing saw chain

#### ⚠CAUTION:

- Always wear gloves when installing or removing the saw chain.
- The saw chain and the guide bar are still hot just after the operation. Let them cool down enough before carrying out any work on the tool.

To remove the saw chain, perform the following steps:

1. Press and fully open the lever until it stops.

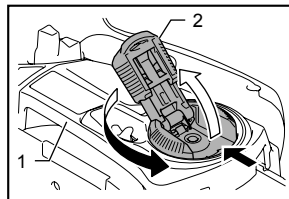

1. Sprocket cover
2. Lever

014674

- Turn the adjusting dial to "-" direction to release the saw chain tension.

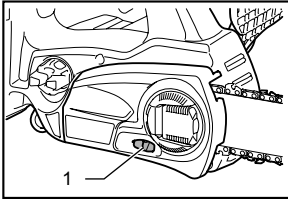

1. Adjusting dial

014653

- Turn the lever counterclockwise to loosen the sprocket cover until it comes off.
- Remove the sprocket cover.
- Remove the saw chain and guide bar from the chain saw.

To install the saw chain, perform the following steps:

- Make sure the direction of the chain. The arrow mark on the chain shows the direction of the chain.

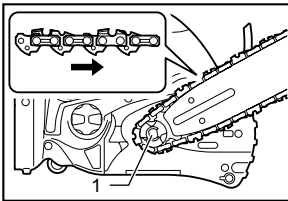

1. Sprocket

014660

- Fit in one end of the saw chain on the top of the guide bar and the other end of it around the sprocket.
- Rest the guide bar in place on the chain saw.
- Turn the adjusting dial to "-" direction to slide the adjusting pin in the direction of arrow.

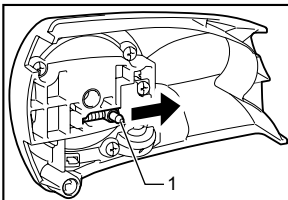

1. Adjusting pin

014659

- Place the sprocket cover on the chain saw so that the adjusting pin is positioned in a small hole in the guide bar.

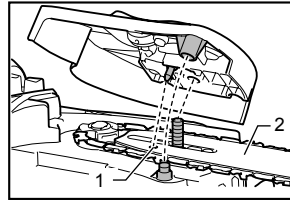

1. Hole  
2. Guide bar

014661

- Turn the lever clockwise fully and a quarter turn back to keep looseness for adjusting chain tension.
- Turn the adjusting dial, and adjust the chain tension.
- Turn the lever clockwise to secure the sprocket cover.

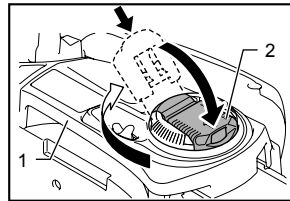

1. Sprocket cover  
2. Lever

014675

- Press and return the lever to its original position.

### Adjusting saw chain tension

The saw chain may become loose after many hours of use. From time to time check the saw chain tension before use.

- Press and fully open the lever until it clicks. Turn it counterclockwise a little to loosen sprocket cover lightly.

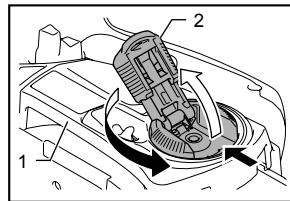

1. Sprocket cover  
2. Lever

014674

- Lift up the guide bar tip slightly.

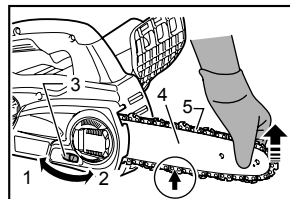

1. Loosen  
2. Tighten  
3. Adjusting dial  
4. Guide bar  
5. Saw chain

014712

- Turn the adjusting dial to adjust the saw chain tension. Tighten the saw chain until the lower side of the saw chain fits in the guide bar rail (see circle in the figure).
- Keep holding the guide bar lightly and tighten the sprocket cover after adjusting the chain tension. Make sure that the saw chain does not loose at lower side.
- Press and return the lever to its original position.

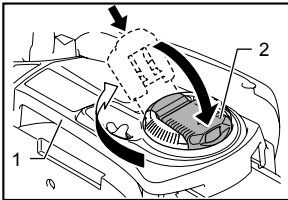

- Sprocket cover
- Lever

014675

Make sure the saw chain fits snugly against the lower side of the bar.

#### ⚠CAUTION:

- Do not tighten the saw chain too much. Excessively high tension of saw chain may cause breakage of saw chain, wear of the guide bar and breakage of the adjusting dial.
- A chain which is too loose can jump off the bar, and therefore presents an accident risk.
- Carry out the procedure of installing or removing saw chain in a clean place free from sawdust and the like.

#### Spike bumper (optional accessory)

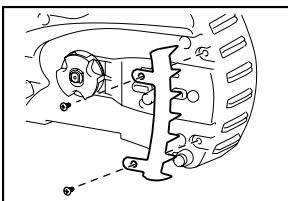

014820

To install spike bumper, perform the following steps:

- Remove the sprocket cover, saw chain and guide bar as described in this instruction manual.
- Fit the holes of spike bumper along with the holes on the chainsaw.
- Tighten them firmly with screws.

## OPERATION

#### ⚠CAUTION:

Do not cover vents, or it may cause overheating and damage to the tool.

#### Lubrication

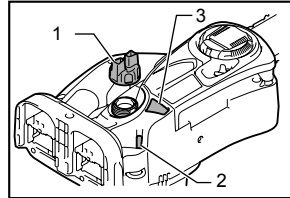

- Oil tank cap
- Oil inspection window ( for refilling the tank with oil)
- Oil inspection window

014655

Saw chain is automatically lubricated when the tool is in operation.

Check the amount of remaining oil in the oil tank through the oil inspection window.

To refill the tank, remove the cap from the oil tank opening.

After refilling the tank, always screw the provided oil tank cap on the chain saw.

#### ⚠CAUTION:

- When filling the chain saw with chain oil for the first time, or refilling the tank after it has been completely emptied, add oil up to the bottom edge of the filler neck. The oil delivery may otherwise be impaired.
- As a saw chain oil, use oil exclusively for Makita chain saws or oil available in market.
- Never use oil including dust and particles or volatile oil.
- When pruning trees, use botanical oil. Mineral oil may harm trees.
- Never force the chain saw when pruning trees.
- Before cutting out, make sure that the provided oil tank cap is screwed in place.

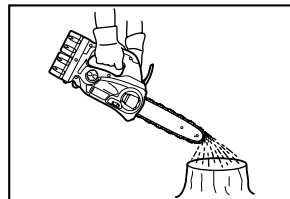

014669

Hold the chain saw away from the tree. Start it and wait until lubrication on saw chain is adequate.

Bring the spike bumper into contact with the branch to be cut before switching on. Otherwise it may cause the guide bar to wobble, resulting in injury to operator. Saw the wood to be cut by just moving it down.

## WORKING WITH THE CHAIN SAW

### ⚠ CAUTION:

- The first time user should, as a minimum practice, do cutting logs on a saw-horse or cradle.
- When sawing pre-cut timber use a safe support (saw horse or cradle). Do not steady the workpiece with your foot, and do not allow anyone else to hold or steady it.
- Secure round pieces against rotation.

### Pruning trees

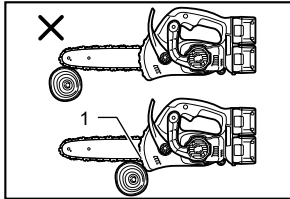

014668

1. Spike bumper

### ⚠ CAUTION:

- Keep all parts of the body away from the saw chain when the motor is operating.
- Hold the chain saw firmly with both hands when the motor is running.
- Do not overreach. Keep proper footing and balance at all times.

Bring the spike bumper into contact with the branch to be cut before switching on. Cutting without bringing the spike bumper into contact with the branch may cause the guide bar to wobble, resulting in injury to operator.

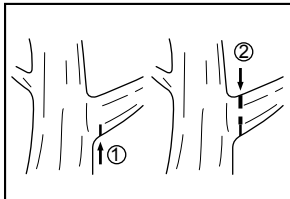

008576

When cutting thick branches, first make a shallow undercut and then make the finish cut from the top.

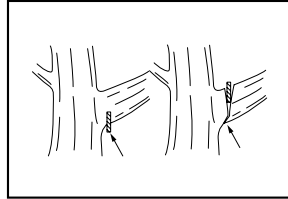

001742

If you try to cut off thick branches from the bottom, the branch may close in and pinch the saw chain in the cut. If you try to cut off thick branches from the top without a shallow undercut, the branch may splinter.

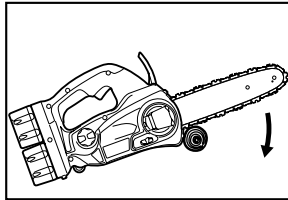

014714

If you cannot cut the timber right through with a single stroke:

Apply light pressure to the handle and continue sawing and draw the chain saw back a little; then apply the spike a little lower and finish the cut by raising the handle.

### Bucking

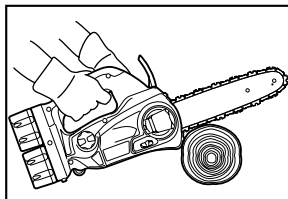

014667

For bucking cuts, rest the spike bumper shown in the figure on the wood to be cut.

With the saw chain running, saw into the wood, using the top handle to raise the saw and the front one to guide it. Use the spike bumper as a pivot.

Continue the cut by applying slight pressure to the front handle, easing the saw back slightly. Move the spike bumper further down the timber and raise the front handle again.

When making several cuts, switch the chain saw off between cuts.

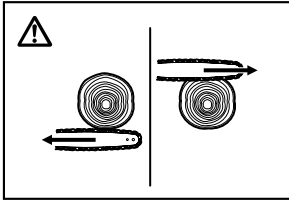

006914

**⚠CAUTION:**

- If the upper edge of the bar is used for cutting, the chain saw may be deflected in your direction if the chain becomes trapped. For this reason, cut with the lower edge, so that the saw will be deflected away from your body.

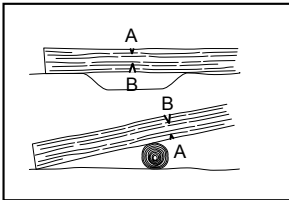

006915

Cut wood under tension on the pressure side (A) first. Then make the final cut on the tension side (B). This prevents the bar from becoming trapped.

**Limbing**

**⚠CAUTION:**

- Limbing may only be performed by trained persons. A hazard is presented by the risk of kickback.

When limbing, support the chain saw on the trunk if possible. Do not cut with the tip of the bar, as this presents a risk of kickback.

Pay particular attention to branches under tension. Do not cut unsupported branches from below.

Do not stand on the felled trunk when limbing.

**Burrowing and parallel-to-grain cuts**

**⚠CAUTION:**

- Burrowing and parallel-to-grain cuts may only be carried out by persons with special training. The possibility of kickback presents a risk of injury.

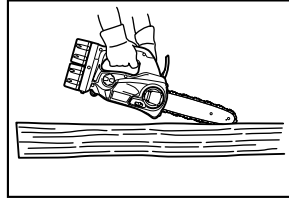

014713

Perform parallel-to-grain cuts at as shallow an angle as possible. Carry out the cut as carefully as possible, as the spike bumper cannot be used.

**Felling**

**⚠CAUTION:**

- Felling work may only be performed by trained persons. The work is hazardous.

Observe local regulations if you wish to fell a tree.

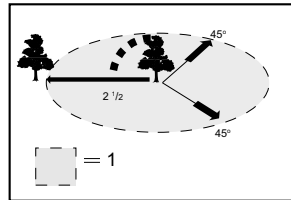

006917

**1. Felling area**

- Before starting felling work, ensure that:
  - (1) Only persons involved in the felling operation are in the vicinity;
  - (2) Any person involved has an unhindered path of retreat through a range of approximately 45 ° either side of the felling axis. Consider the additional risk of tripping over electrical cables;
  - (3) The base of the trunk is free of foreign objects, roots and ranches;
  - (4) No persons or objects are present over a distance of 2 1/2 tree lengths in the direction in which the tree will fall.
- Consider the following with respect to each tree:
  - Direction of lean;
  - Loose or dry branches;
  - Height of the tree;
  - Natural overhang;
  - Whether or not the tree is rotten.
- Consider the wind speed and direction. Do not carry out felling work if the wind is gusting strongly.
- Trimming of root swellings: Begin with the largest swellings. Make the vertical cut first, then the horizontal cut.

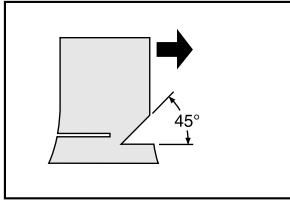

006918

- Cut a scarf: The scarf determines the direction in which the tree will fall, and guides it. It is made on the side towards which the tree is to fall. Cut the scarf as close to the ground as possible. First make the horizontal cut to a depth of 1/5 -1/3 of the trunk diameter. Do not make the scarf too large. Then make the diagonal cut.
- Cut any corrections to the scarf across its entire width.

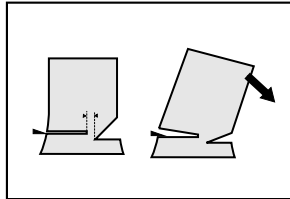

006923

- Make the back cut a little higher than the base cut of the scarf. The back cut must be exactly horizontal. Leave approximately 1/10 of the trunk diameter between the back cut and the scarf. The wood fibers in the uncut trunk portion act as a hinge. Do not cut right through the fibers under any circumstances, as the tree will otherwise fall unchecked. Insert wedges into the back cut in time.
- Only plastic or aluminum wedges may be used to keep the back cut open. The use of iron wedges is prohibited.
- Stand to the side of the falling tree. Keep an area clear to the rear of the falling tree up to an angle of 45 ° either side of the tree axis (refer to the " felling area " figure). Pay attention to falling branches.
- An escape path should be planned and cleared as necessary before cuts are started. The escape path should extend back and diagonally to the rear of the expected line of fall as illustrated in figure.

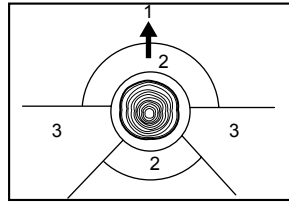

009202

1. Felling direction
2. Danger zone
3. Escape route

### Carrying tool

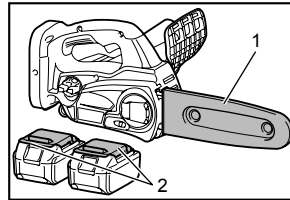

014665

1. Guide bar cover
2. Battery cover

Always remove the battery cartridge from the tool and overlap the guide bar with the guide bar cover before carrying the tool. Also cover the battery cartridge with the battery cover.

## MAINTENANCE

### ⚠CAUTION:

- Always be sure that the tool is switched off and the battery cartridge is removed before attempting to perform inspection or maintenance.
- Always wear gloves when performing any inspection or maintenance.
- Never use gasoline, benzine, thinner, alcohol or the like. Discoloration, deformation or cracks may result.

### Sharpening the saw chain

### ⚠CAUTION:

- Always remove the battery cartridge and wear safety gloves when performing work on the saw chain.

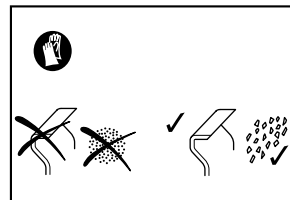

008633

**Sharpen the saw chain when:**

- Mealy sawdust is produced when damp wood is cut;
- The chain penetrates the wood with difficulty, even when heavy pressure is applied;
- The cutting edge is obviously damaged;
- The saw pulls to the left or right in the wood. The reason for this behaviour is uneven sharpening of the saw chain, or damage to one side only.

**Sharpen the saw chain frequently, but remove only a little material each time.**

Two or three strokes with a file are usually sufficient for routine resharpener. When the chain has been resharpened several times, have it sharpened in a MAKITA specialist repair shop.

**Sharpening criteria:**

- All cutter length must be equal. Cutters of differing length prevent the chain from running smoothly, and may cause the chain to break.
- Do not sharpen the chain once a minimum cutter length of 3 mm has been reached. A new chain must then be fitted.
- The chip thickness is determined by the distance between the depth gauge (round nose) and the cutting edge.
- The best cutting results are obtained with following distance between cutting edge and depth gauge.
  - Chain blade 90PX: 0.5 mm
  - Chain blade 91PX: 0.65 mm
  - Chain blade 25AP: 0.65 mm

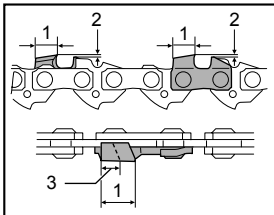

1. Cutting length
2. Distance between cutting edge and depth gauge
3. Minimum 3 mm

014456

**⚠WARNING:**

- An excessive distance increases the risk of kick-back.
- The sharpening angle of 30 ° must be the same on all cutters. Differences in angle cause the chain to run roughly and unevenly, accelerate wear, and lead to chain breaks.
- The side plate angle of the cutter is determined by the depth of penetration of the round file. If the specified file is used properly, the correct side plate angle is produced automatically.
- Side plate angle for each saw chain are as follows:
  - Chain blade 90PX: 75 °
  - Chain blade 91PX: 80 °
  - Chain blade 25AP: 85 °

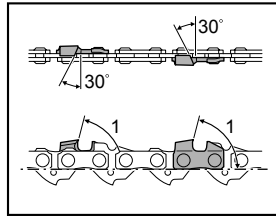

014455

1. Side plate angle

**File and file guiding**

- Use a special round file (optional accessory) for saw chains to sharpen the chain. Normal round files are not suitable.
- Diameter of the round file for each saw chain is as follows:
  - Chain blade 90PX: 4.5 mm
  - Chain blade 91PX: 4.0 mm
  - Chain blade 25AP: 4.0 mm
- The file should only engage the cutter on the forward stroke. Lift the file off the cutter on the return stroke.
- Sharpen the shortest cutter first. Then the length of this shortest cutter becomes the standard for all other cutters on the saw chain.

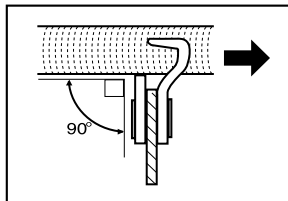

006927

- Guide the file as shown in the figure.
- The file can be guided more easily if a file holder (optional accessory) is employed. The file holder has markings for the correct sharpening angle of 30 ° (align the markings parallel to the saw chain) and limits the depth of penetration (to 4/5 of the file diameter).

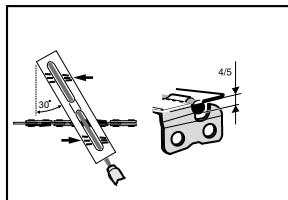

006926



- After sharpening the chain, check the height of the depth gauge using the chain gauge tool (optional accessory).

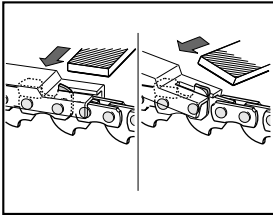

014344

- Remove any projecting material, however small, with a special flat file (optional accessory).
- Round off the front of the depth gauge again.

### Cleaning guide bar

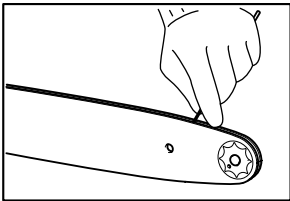

010924

Chips and sawdust will build up in the guide bar groove, clogging it and impairing oil flow. Always clean out the chips and sawdust when sharpening or replacing the saw chain.

### Cleaning the oil discharge hole

Small dust or particles may be built up in the oil discharge hole during operation.

Small dust or particles built up in the oil discharge hole may impair the oil discharge flow and cause an insufficient lubrication on the whole saw chain.

When a poor chain oil delivery occurs at the top of guide bar, clean the oil discharge hole as follows.

Remove the battery cartridge from the tool.

Remove the sprocket cover and saw chain from the tool. (Refer to the section titled "Installing or removing saw chain".)

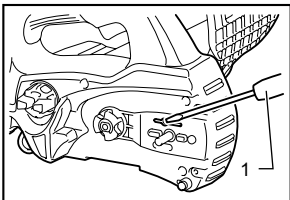

014671

1. Slotted screwdriver

Remove the small dust or particles using a slotted screwdriver with a slender shaft or the like.

Insert the battery cartridge into the tool.

Pull the switch trigger to flow built-up dust or particles off the oil discharge hole by discharging chain oil.

Remove the battery cartridge from the tool.

Reinstall the sprocket cover and saw chain on the tool.

### Replacing the sprocket

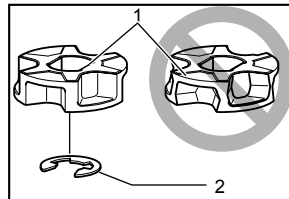

1. Sprocket
2. Locking ring

010927

Before fitting a new saw chain, check the condition of the sprocket.

### CAUTION:

- A worn sprocket will damage a new saw chain. Have the sprocket replaced in this case. The sprocket needs to be installed so that it always faces as shown in the figure.

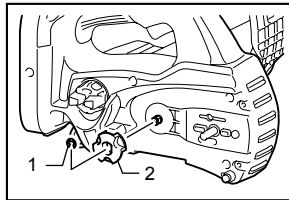

1. Locking ring
2. Sprocket

014715

Always fit a new locking ring when replacing the sprocket.

### Replacing carbon brushes

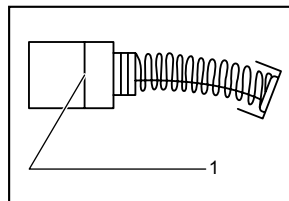

1. Limit mark

001145

Remove and check the carbon brushes regularly. Replace when they wear down to the limit mark. Keep the carbon brushes clean and free to slip in the holders. Both carbon brushes should be replaced at the same time. Use only identical carbon brushes.

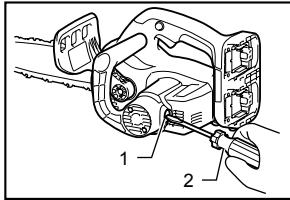

1. Brush holder cap
2. Screwdriver

014672

Use a screwdriver to remove the brush holder caps. Take out the worn carbon brushes, insert the new ones and secure the brush holder caps.

### Storing tool

Clean the tool before storing. Remove any chips and sawdust from the tool after removing the sprocket cover. After cleaning the tool, run it under no load to lubricate the saw chain and guide bar.

Cover the guide bar with the guide bar cover.

Remove oil from the oil tank to empty it and place the chain saw.

To maintain product SAFETY and RELIABILITY, repairs, any other maintenance or adjustment should be performed by Makita Authorized Service Centers, always using Makita replacement parts.

### Instructions for periodic maintenance

To ensure long life, prevent damage and ensure the full functioning of the safety features the following maintenance must be performed regularly.

Warranty claims can be recognized only if this work is performed regularly and properly. Failure to perform the prescribed maintenance work can lead to accidents!

The user of the chain saw must not perform maintenance work which is not described in the instruction manual. All such work must be carried out by authorized service centre.

Item	Operating time	Before operation	Everyday	Every week	Every 3 month	Annually	Before storage
Chain saw	Inspection.	○					
	Cleaning.		○				
	Check at authorized service center.					○	○
Saw chain	Inspection.	○					
	Sharpening if necessary.						○
Guide bar	Inspection.	○	○				
	Remove from the chain saw.						○
Chain brake	Check the function.	○					
	Have it inspected regularly at authorized service center.				○		
Chain lubrication	Check the oil feed rate.	○					
Switch trigger	Inspection.	○					
Lock-off button	Inspection.	○					
Oil tank cap	Check tightness.	○					
Chain catcher	Inspection.			○			
Screws and nuts	Inspection.			○			

014804

## TROUBLE SHOOTING

Before asking for repairs, conduct your own inspection first. If you find a problem that is not explained in the manual, do not attempt to dismantle the tool. Instead, ask Makita Authorized Service Centers, always using Makita replacement parts for repairs.

Malfunction status	Cause	Action
Chain saw does not start.	Two battery cartridges are not installed.	Install the charged battery cartridges.
	Battery problem (under voltage).	Recharge the battery cartridge. If recharging is not effective, replace battery cartridge.
Chain does not run.	Chain brake activated.	Release chain brake.
Motor stops running after a little use.	Battery's charge level is low.	Recharge the battery cartridge. If recharging is not effective, replace battery cartridge.
No oil on the chain.	Oil tank is empty.	Fill the oil tank.
	Oil guide groove is dirty.	Clean the groove.
	Oil delivery is not adjusted properly.	Adjust amount of oil delivery.
It does not reach maximum RPM.	Battery cartridge is installed improperly.	Install the battery cartridge as described in this manual.
	Battery power is dropping.	Recharge the battery cartridge. If recharging is not effective, replace battery cartridge.
	The drive system does not work correctly.	Ask your local authorized service center for repair.
Chain does not stop even the chain brake is activated: Stop the machine immediately!	Brake band worn down.	Ask your local authorized service center for repair.
Abnormal vibration: Stop the machine immediately!	Loose guide bar or saw chain.	Adjust the guide bar and saw chain tension.
	Tool malfunction.	Ask your local authorized service center for repair.

014805

## OPTIONAL ACCESSORIES

### CAUTION:

- These accessories or attachments are recommended for use with your Makita tool specified in this manual. The use of any other accessories or attachments might present a risk of injury to persons. Only use accessory or attachment for its stated purpose.

If you need any assistance for more details regarding these accessories, ask your local Makita Service Center.

- Makita genuine battery and charger
- Saw chain
- Guide bar
- Guide bar cover
- File
- Tool bag

### NOTE:

- Some items in the list may be included in the tool package as standard accessories. They may differ from country to country.

**Makita** Jan-Baptist Vinkstraat 2, 3070, Belgium  
**Makita Corporation** Anjo, Aichi, Japan