

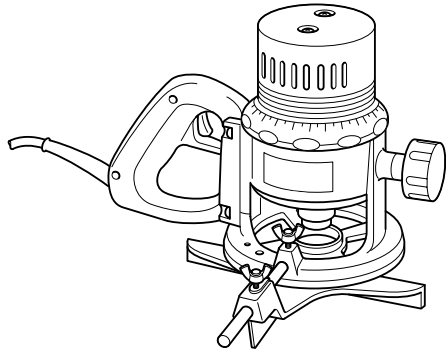

Router

MODEL 3601B



005038



INSTRUCTION MANUAL

⚠ WARNING:

For your personal safety, READ and UNDERSTAND before using.
SAVE THESE INSTRUCTIONS FOR FUTURE REFERENCE.

SPECIFICATIONS

Model	3601B
Collet chuck capacity	12 mm
No load speed (min ⁻¹)	23,000
Overall height	190 mm
Net weight	3.5 kg
Safety class	□ /II

- Due to our continuing programme of research and development, the specifications herein are subject to change without notice.
- Note: Specifications may differ from country to country.

SYMBOLS

END201-1

The following show the symbols used for the tool. Be sure that you understand their meaning before use.



.....Read instruction manual.



.....DOUBLE INSULATION

Intended use

The tool is intended for flush trimming and profiling of wood, plastic and similar materials.

Power supply

The tool should be connected only to a power supply of the same voltage as indicated on the nameplate, and can only be operated on single-phase AC supply. They are double-insulated in accordance with European Standard and can, therefore, also be used from sockets without earth wire.

For European countries only

Noise and Vibration

The typical A-weighted noise levels are
sound pressure level: 94 dB (A)
sound power level: 105 dB (A)
Uncertainty: 3 dB(A)

– Wear ear protection. –

The typical weighted root mean square acceleration value is not more than 2.5 m/s².

These values have been obtained according to EN60745.

EC-DECLARATION OF CONFORMITY

We declare under our sole responsibility that this product is in compliance with the following standards of standardized documents, EN60745, EN55014, EN61000 in accordance with Council Directives, 73/23/EEC, 89/336/EEC, 98/37/EC.

Yasuhiko Kanzaki **CE 2004**

Director

MAKITA INTERNATIONAL EUROPE LTD.

Michigan Drive, Tongwell, Milton Keynes, Bucks MK15 8JD, ENGLAND

Responsible manufacturer:

Makita Corporation Anjo Aichi Japan

SAFETY INSTRUCTIONS

ENA001-2

WARNING:

When using electric tools, basic safety precautions, including the following, should always be followed to reduce the risk of fire, electric shock and personal injury. Read all these instructions before operating this product and save these instructions.

For safe operations:

- 1. Keep work area clean.**
Cluttered areas and benches invite injuries.
- 2. Consider work area environment.**
Do not expose power tools to rain. Do not use power tools in damp or wet locations. Keep work area well lit. Do not use power tools where there is risk to cause fire or explosion.
- 3. Guard against electric shock.**
Avoid body contact with earthed or grounded surfaces (e.g. pipes, radiators, ranges, refrigerators).
- 4. Keep children away.**
Do not let visitors touch the tool or extension cord. All visitors should be kept away from work area.
- 5. Store idle tools.**
When not in use, tools should be stored in a dry, high or locked up place, out of reach of children.
- 6. Do not force the tool.**
It will do the job better and safer at the rate for which it was intended.
- 7. Use the right tool.**
Do not force small tools or attachments to do the job of a heavy duty tool. Do not use tools for purposes not intended; for example, do not use circular saws to cut tree limbs or logs.
- 8. Dress properly.**
Do not wear loose clothing or jewellery, they can be caught in moving parts. Rubber gloves and non-skid footwear are recommended when working outdoors. Wear protecting hair covering to contain long hair.
- 9. Use safety glasses and hearing protection.**
Also use face or dust mask if the cutting operation is dusty.
- 10. Connect dust extraction equipment.**
If devices are provided for the connection of dust extraction and collection facilities ensure these are connected and properly used.
- 11. Do not abuse the cord.**
Never carry the tool by the cord or yank it to disconnect it from the socket. Keep the cord away from heat, oil and sharp edges.
- 12. Secure work.**
Use clamps or a vice to hold the work. It is safer than using your hand and it frees both hands to operate the tool.
- 13. Do not overreach.**
Keep proper footing and balance at all times.
- 14. Maintain tools with care.**
Keep cutting tools sharp and clean for better and safer performance. Follow instructions for lubrication and changing accessories. Inspect tool cord periodically and if damaged have it repaired by an authorized service facility. Inspect extension cords periodically and replace, if damaged. Keep handles dry, clean and free from oil and grease.
- 15. Disconnect tools.**
When not in use, before servicing and when changing accessories such as blades, bits and cutters.
- 16. Remove adjusting keys and wrenches.**
Form the habit of checking to see that keys and adjusting wrenches are removed from the tool before turning it on.
- 17. Avoid unintentional starting.**
Do not carry a plugged-in tool with a finger on the switch. Ensure switch is off when plugging in.
- 18. Use outdoor extension leads.**
When tool is used outdoors, use only extension cords intended for outdoor use.
- 19. Stay alert.**
Watch what you are doing. Use common sense. Do not operate tool when you are tired.
- 20. Check damaged parts.**
Before further use of the tool, a guard or other part that is damaged should be carefully checked to determine that it will operate properly and perform its intended function. Check for alignment of moving parts, free running of moving parts, breakage of parts, mounting and any other conditions that may affect its operation. A guard or other part that is damaged should be properly repaired or replaced by an authorized service center unless otherwise indicated in this instruction manual. Have defective switches replaced by an authorized service facility. Do not use the tool if the switch does not turn it on and off.
- 21. Warning.**
The use of any accessory or attachment, other than those recommended in this instruction manual or the catalog, may present a risk of personal injury.
- 22. Have your tool repaired by a qualified person.**
This electric tool is in accordance with the relevant safety requirements. Repairs should only be carried out by qualified persons using original spare parts, otherwise this may result in considerable danger to the user.

ADDITIONAL SAFETY RULES

ENB033-2

1. **Hold tool by insulated gripping surfaces when performing an operation where the cutting tool may contact hidden wiring or its own cord.** Contact with a "live" wire will make exposed metal parts of the tool "live" and shock the operator.
2. **Wear hearing protection during extended period of operation.**
3. **Handle the bits very carefully.**
4. **Check the bit carefully for cracks or damage before operation. Replace cracked or damaged bit immediately.**
5. **Avoid cutting nails. Inspect for and remove all nails from the workpiece before operation.**
6. **Hold the tool firmly with both hands.**
7. **Keep hands away from rotating parts.**
8. **Make sure the bit is not contacting the workpiece before the switch is turned on.**
9. **Before using the tool on an actual workpiece, let it run for a while. Watch for vibration or wobbling that could indicate improperly installed bit.**
10. **Be careful of the bit rotating direction and the feed direction.**
11. **Do not leave the tool running. Operate the tool only when hand-held.**
12. **Always switch off and wait for the bit to come to a complete stop before removing the tool from workpiece.**
13. **Do not touch the bit immediately after operation; it may be extremely hot and could burn your skin.**
14. **Always lead the power supply cord away from the tool towards the rear.**
15. **Do not smear the tool base carelessly with thinner, gasoline, oil or the like. They may cause cracks in the tool base.**
16. **Draw attention to the need to use cutters of the correct shank diameter and which are suitable for the speed of the tool.**

SAVE THESE INSTRUCTIONS

FUNCTIONAL DESCRIPTION

⚠ CAUTION:

- Always be sure that the tool is switched off and unplugged before adjusting or checking function on the tool.

005039

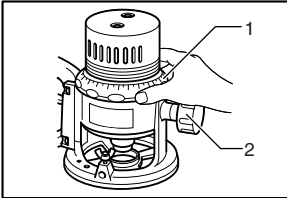

1. Scale ring
2. Knob

Adjusting the depth of cut

Place the tool on a flat surface. Turn the scale ring until it makes contact with the base. Loosen the knob. Turn the scale ring until the bit just touches the flat surface. Tighten the knob. Place the tool on its side and turn the scale ring counterclockwise (when viewing the tool from the top) until the desired depth of cut is obtained. One full turn of the scale ring is equal to 5 mm change in depth setting. Loosen the knob and move the tool base until it makes contact with the scale ring. Then tighten the knob securely.

⚠ CAUTION:

- Since excessive cutting may cause overload of the motor or difficulty in controlling the tool, the depth of cut should not be more than 15 mm at a pass when cutting grooves. When you wish to cut grooves more than 15 mm deep, make several passes with progressively deeper bit settings.

005040

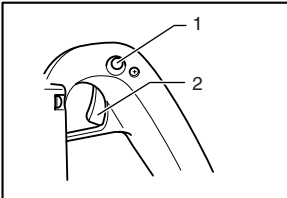

1. Lock button
2. Switch trigger

Switch action

⚠ CAUTION:

- Before plugging in the tool, always check to see that the switch trigger actuates properly and returns to the "OFF" position when released.

For tool with lock button

To start the tool, simply pull the switch trigger. Release the switch trigger to stop.

For continuous operation, pull the switch trigger and then push in the lock button.

To stop the tool from the locked position, pull the switch trigger fully, then release it.

For tool without lock button

To start the tool, simply pull the switch trigger. Release the switch trigger to stop.

005041

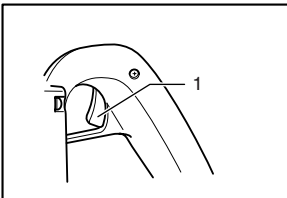

1. Switch trigger

ASSEMBLY

⚠ CAUTION:

- Always be sure that the tool is switched off and unplugged before carrying out any work on the tool.

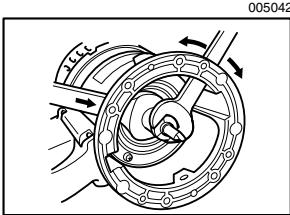

Installing or removing the bit

⚠ CAUTION:

- Install the bit securely. Always use only the wrenches provided with the tool. A loose or overtightened bit can be dangerous.
- Do not tighten the collet chuck without inserting a bit or install smaller shank bits without using a collet sleeve. Either can lead to breakage of the collet chuck.

Insert the bit all the way into the collet chuck and withdraw it very slightly (approx. 2 mm). Then tighten the collet chuck securely with the two wrenches. When using smaller shank bits, first insert the appropriate collet sleeve into the collet chuck, then install the bit as mentioned above.

To remove the bit, follow the installation procedure in reverse.

OPERATION

Set the tool base on the workpiece to be cut without the bit making any contact. Then turn the tool on and wait until the bit attains full speed. Move the tool forward over the workpiece surface, keeping the tool base flush and advancing smoothly until the cutting is complete.

When doing edge cutting, the workpiece surface should be on the left side of the bit in the feed direction.

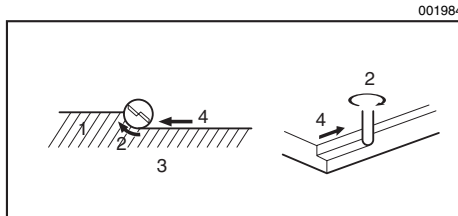

1. Workpiece
2. Bit revolving direction
3. View from the top of the tool
4. Feed direction

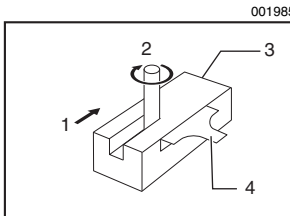

1. Feed direction
2. Bit revolving direction
3. Workpiece
4. Straight guide

NOTE:

- Moving the tool forward too fast may cause a poor quality of cut, or damage to the bit or motor. Moving the tool forward too slowly may burn and mar the cut. The proper feed rate will depend on the bit size, the kind of workpiece and depth of cut. Before beginning the cut on the actual workpiece, it is advisable to make a sample cut on a piece of scrap lumber. This will show exactly how the cut will look as well as enable you to check dimensions.
- When using the straight guide or the trimmer guide, be sure to install it on the right side in the feed direction. This will help to keep it flush with the side of the workpiece.

005043

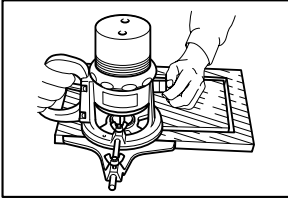

Straight guide

The straight guide is effectively used for straight cuts when chamfering or grooving.

005044

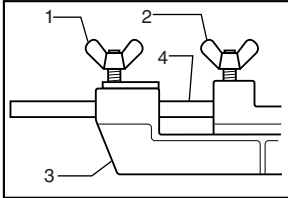

To install the straight guide, insert the guide bar into the holes in the tool base until the notch in the guide bar reaches just under the wing bolt (B). Then tighten wing bolt (B). Loosen the wing bolt (A) and adjust the distance between the bit and the straight guide. At the desired distance, tighten the wing bolt (A) to secure the straight guide in place.

When cutting, move the tool with the straight guide flush with the side of the workpiece.

1. Wing bolt (B)
2. Wing bolt (A)
3. Straight guide
4. Guide bar

005045

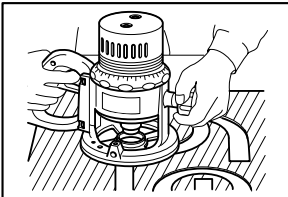

Templet guide (Accessory)

The templet guide provides a sleeve through which the bit passes, allowing use of the tool with templet patterns.

005046

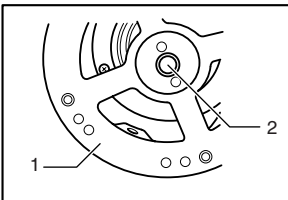

To install the templet guide, screw the templet guide on the base plate.

1. Base plate
2. Templet guide

003695

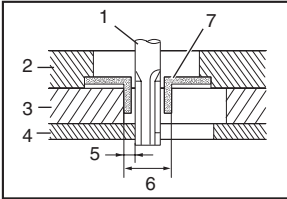

1. Bit
2. Base
3. Templet
4. Workpiece
5. Distance (X)
6. Outside diameter of the templet guide
7. Templet guide

Secure the templet to the workpiece. Place the tool on the templet and move the tool with the templet guide sliding along the side of the templet.

NOTE:

- The workpiece will be cut a slightly different size from the templet. Allow for the distance (X) between the bit and the outside of the templet guide. The distance (X) can be calculated by using the following equation:
Distance (X) = (outside diameter of the templet guide - bit diameter) / 2

005047

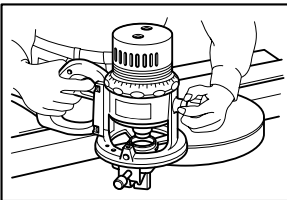

Trimmer guide (Accessory)

Trimming, curved cuts in veneers for furniture and the like can be done easily with the trimmer guide. The guide roller rides the curve and assures a fine cut.

005048

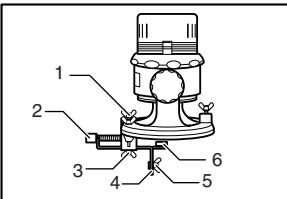

1. Wing bolt (B)
2. Fine adjusting screw
3. Wing bolt (A)
4. Trimmer guide
5. Wing bolt (C)
6. Guide roller

Install the trimmer guide on the tool base with the wing bolts (B). Loosen the wing bolt (A) and adjust the distance between the bit and the trimmer guide by turning the fine adjusting screw (1.5 mm per turn). At the desired distance, tighten the wing bolt (A) to secure the trimmer guide in place. When adjusting the guide roller up or down, loosen the wing bolt (C). After adjusting it, tighten the wing bolt (C) securely.

003701

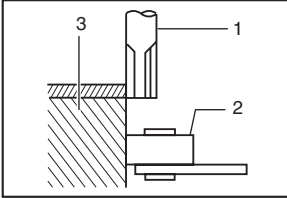

1. Bit
2. Guide roller
3. Workpiece

When cutting, move the tool with the guide roller riding the side of the workpiece.

006286

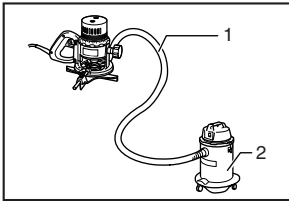

1. Vacuum hose
2. Vacuum cleaner

Connecting a vacuum cleaner

Connect a vacuum hose to the tool and further connect another end of it to the vacuum cleaner. Secure the hose to the router base with a screw in the figure.

006287

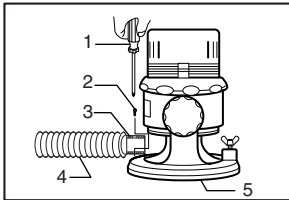

1. Screwdriver
2. Screw
3. Hole
4. Vacuum hose
5. Router base

006288

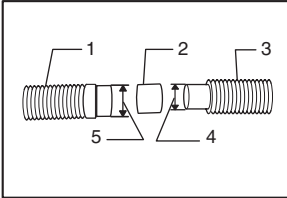

1. Hose
2. Joint
3. Vacuum hose
4. Outer diameter $\varnothing 32$ mm
5. Inner diameter $\varnothing 38$ mm

Connect another end of the hose to the vacuum cleaner hose of 38 mm in inner diameter using a joint.

MAINTENANCE

CAUTION:

- Always be sure that the tool is switched off and unplugged before attempting to perform inspection or maintenance.

001145

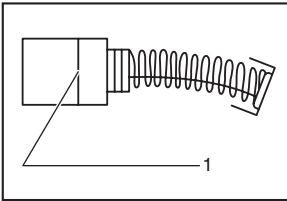

1. Limit mark

Replacing carbon brushes

Remove and check the carbon brushes regularly. Replace when they wear down to the limit mark. Keep the carbon brushes clean and free to slip in the holders. Both carbon brushes should be replaced at the same time. Use only identical carbon brushes.

005049

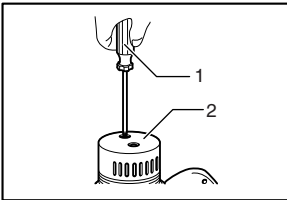

1. Screwdriver
2. Rear cover

Use a screwdriver to remove the rear cover.

005050

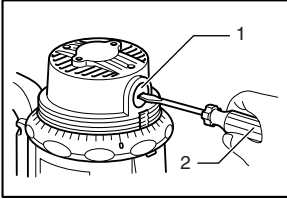

1. Brush holder cap
2. Screwdriver

Use a screwdriver to remove the brush holder caps. Take out the worn carbon brushes, insert the new ones and secure the brush holder caps. Then install the rear cover with the screws.

⚠ CAUTION:

- Do not turn the tool on without the rear cover installed in place.

To maintain product SAFETY and RELIABILITY, repairs, any other maintenance or adjustment should be performed by Makita Authorized Service Centers, always using Makita replacement parts.

ACCESSORIES

⚠ CAUTION:

- These accessories or attachments are recommended for use with your Makita tool specified in this manual. The use of any other accessories or attachments might present a risk of injury to persons. Only use accessory or attachment for its stated purpose.

If you need any assistance for more details regarding these accessories, ask your local Makita service center.

- Straight & groove forming bits
- Edge forming bits
- Laminate trimming bits
- Straight guide assembly
- Trimmer guide assembly
- Templet guide 25
- Templet guides
- Templet guide adapter
- Lock nut
- Collet cone 12 mm, 1/2"
- Collet sleeve 3/8", 1/4"
- Collet sleeve 6 mm, 8 mm, 10 mm
- Wrench 21
- Wrench 23

Makita Corporation Anjo, Aichi, Japan