

Makita[®]

270mm (10-5/8") Circular Saw

HS0600



Product Objectives

- Designed to suit the needs of carpenters, landscapers and builders
- Develop a circular saw with a maximum cutting capacity of 101mm
- The HS0600 will replace the 5104



Product Overview

Magnesium blade case

High power motor

Flat motor housing design

Dust extraction

Large rubber levers

Rear angle guide



Product Specification Sheet



Max. cutting capacities at 90°	101mm
Max. cutting capacities at 45°	71mm
Bevel capacity	0°- 50°
Blade diameter	270mm (10-5/8")
Bore diameter	25.4mm
No load speed	4,300rpm
Continuous rating input	2,100W
Overall length	418mm
Net weight	6.9kg
Power supply cord	2.0m

- **Magnesium blade case** – magnesium is strong, lightweight and resistant to corrosion making the saw durable and comfortable to use
- **Dust extraction** – dust nozzle supplied as standard to efficiently remove dust creating a safer work environment
- **Rear angle guide** – locks the rear of the saw, supplementing the front adjustment for a smooth and precise adjustment of the bevel angle
- **High power motor** – 2,100W motor design delivers 4,300rpm for ripping through tough cuts
- **Flat motor housing design** – increases tool stability when changing blades
- **Large rubber levers** – allow for quick and easy depth and bevel adjustment

Advantages

Capacity



Massive cut capacity of 101mm at 90 degrees

Design

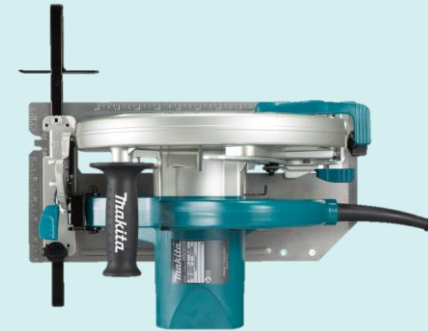

Flat motor housing design for stability when changing blades

Comfort



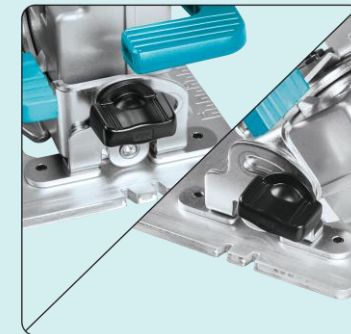

Large rubberized levers for quick and easy depth and bevel adjustment

Accuracy





Dual front and rear bevel supports provide additional rigidity for accurate cutting





Product Replacement

	Makita – NEW HS0600	Makita – Discontinued 5104
		
Max. cutting capacities at 90°	101mm	100mm
Max. cutting capacities at 45°	71mm	73mm
Bevel capacity	0°- 50°	0°- 45°
Blade diameter	270mm (10-5/8")	270mm (10-5/8")
Bore diameter	25.4mm	25.4mm
No load speed	4,300rpm	3,800rpm
Continuous rating input	2,100W	1,700W
Overall length	418mm	405mm
Net weight	6.9kg	8.3kg
Power supply cord	2.0m	2.0m

Our Range



	Makita – NEW HS0600	Makita 5902B	Makita N5900B-2	Makita N5900B	Makita 5008MG
					
Max. cutting capacities at 90°	101mm	85mm	85mm	85mm	75.5mm
Max. cutting capacities at 45°	71mm	60mm	60mm	60mm	57mm
Bevel capacity	0°- 50°	0°- 50°	0°- 50°	0°- 50°	0°- 50°
Blade diameter	270mm (10-5/8")	235mm (9-1/4")	235mm (9-1/4")	235mm (9-1/4")	210mm (8-1/4")
Bore diameter	25.4mm	25mm	25mm	25mm	25mm
No load speed	4,300rpm	4,100rpm	4,100rpm	4,100rpm	5,200rpm
Continuous rating input	2,100W	2,100W	2,000W	2,000W	1,800W
Overall length	418mm	380mm	380mm	380mm	332mm
Net weight	6.9kg	6.7kg	7.0kg	7.0kg	4.8kg
Power supply cord	2.0m	2.0m	2.0m	2.0m	2.0m

Our Range

	Makita 5007NK	Makita 5007MGK	Makita 5057KB	Makita HS7600SP	Makita 5606B
					
Max. cutting capacities at 90°	63.5mm	63.5mm	60mm	64mm	55mm
Max. cutting capacities at 45°	45mm	45mm	30mm	42mm	36mm
Bevel capacity	0°- 56°	0°- 56°	0°- 45°	0°- 45°	0°- 45°
Blade diameter	185mm (7-1/4")	185mm (7-1/4")	185mm (7-1/4")	185mm (7-1/4")	160mm (6-1/4")
Bore diameter	20mm	20mm	20mm	20mm	20mm
No load speed	5,800rpm	5,800rpm	5,800rpm	5,200rpm	5,200rpm
Continuous rating input	1,800W	1,800W	1,400W	1,200W	950W
Overall length	317mm	317mm	354mm	309mm	268mm
Net weight	5.0kg	4.6kg	5.4kg	3.9kg	3.1kg
Power supply cord	2.0m	2.0m	4.0m	2.0m	2.0m

Accessories

Standard Accessories		
	B-15229	TCT Saw Blade
	198265-7	Dust nozzle
	164367-1	Guide rule
	783204-6	Hex wrench
	410047-0	Hex wrench holder

Optional Accessories		
	B-15229 B-15235 B-15241	BlueMak 270 x 25.4 x 18T 270 x 25.4 x 24T 270 x 30 x 40T
	B-37655 191897	Specialized Sandwich Material Blade 270 x 25.4 x 60T Blade wax